

# H.323, Megaco/H.248 and Soft-Switches

**INSE 7110 – Winter 2007**

**Value Added Services Engineering in Next Generation Networks  
Week #5, Lecture 4**

# Outline



1. H.323
2. Megaco/H.248
3. Soft-switches

# H.323

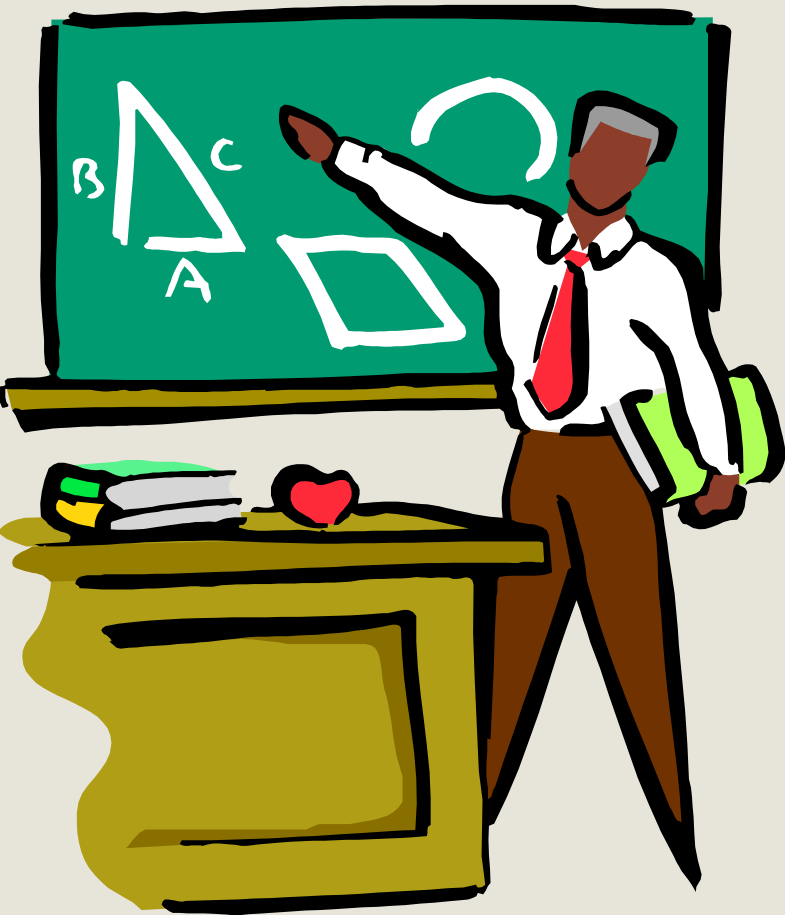

1. Introduction
2. Functional entities
3. Signaling protocols
4. H.323 vs. SIP

## H.323: Introduction

### An umbrella ITU-T standard including

- signalling standards:
  - H.225.0
  - Q.931
  - H.245
- Others (e.g. H.324 Terminal for low bit rate multimedia communications)

## **H.323: The functionality entities**

### **Terminals**

- End point
- Used for real time two way multimedia communications with another end point

### **Gatekeeper**

- Control how terminal access networks
- Provide address translation

### **Gateway**

- End point
- Used for communications between H.323 terminals and terminals in the PSTN

### **Multipoint control unit (MCU)**

- Provides centralized conferencing functionality

# H.323 signaling: Registration Admission and Status (RAS)

## Key features

- ASN.1 based messages
- Request / reply protocol
- Signaling between end-points
  - Terminal or gateway  
and
  - Gatekeeper
- Use unreliable channels
  - Retries
  - Timeouts

## RAS: Gatekeeper discovery ...

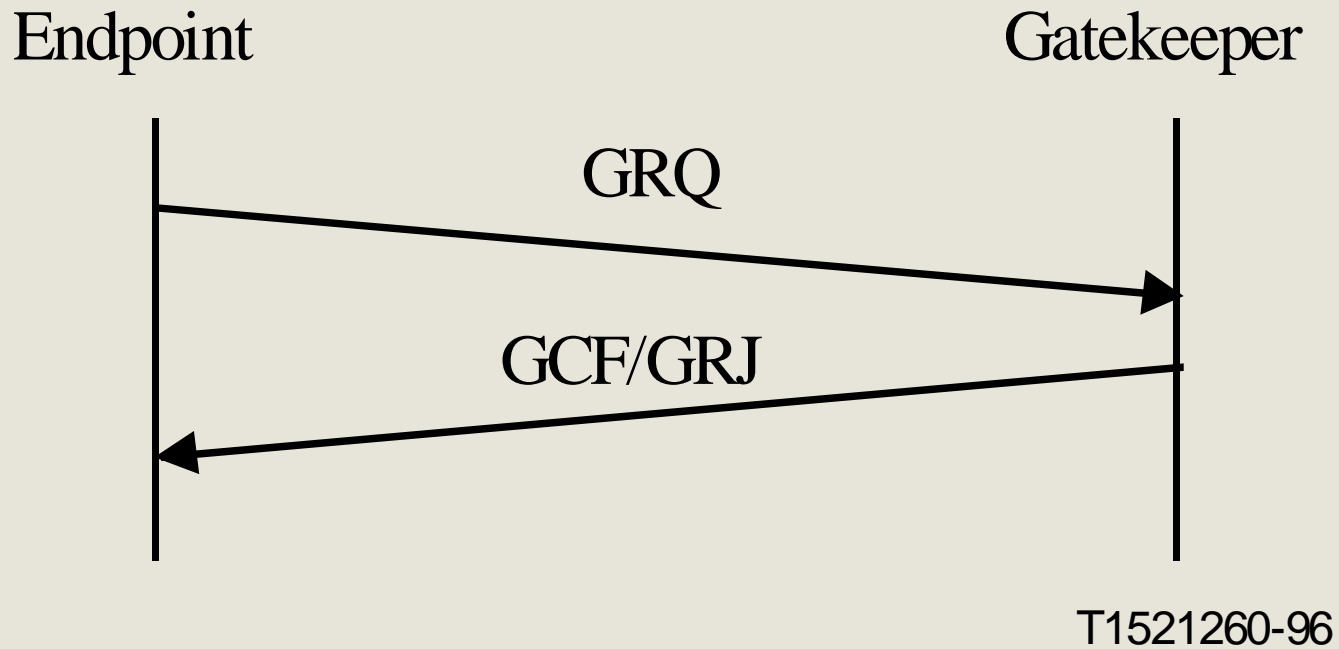

# RAS: Admission request ...

Endpoint

Gatekeeper

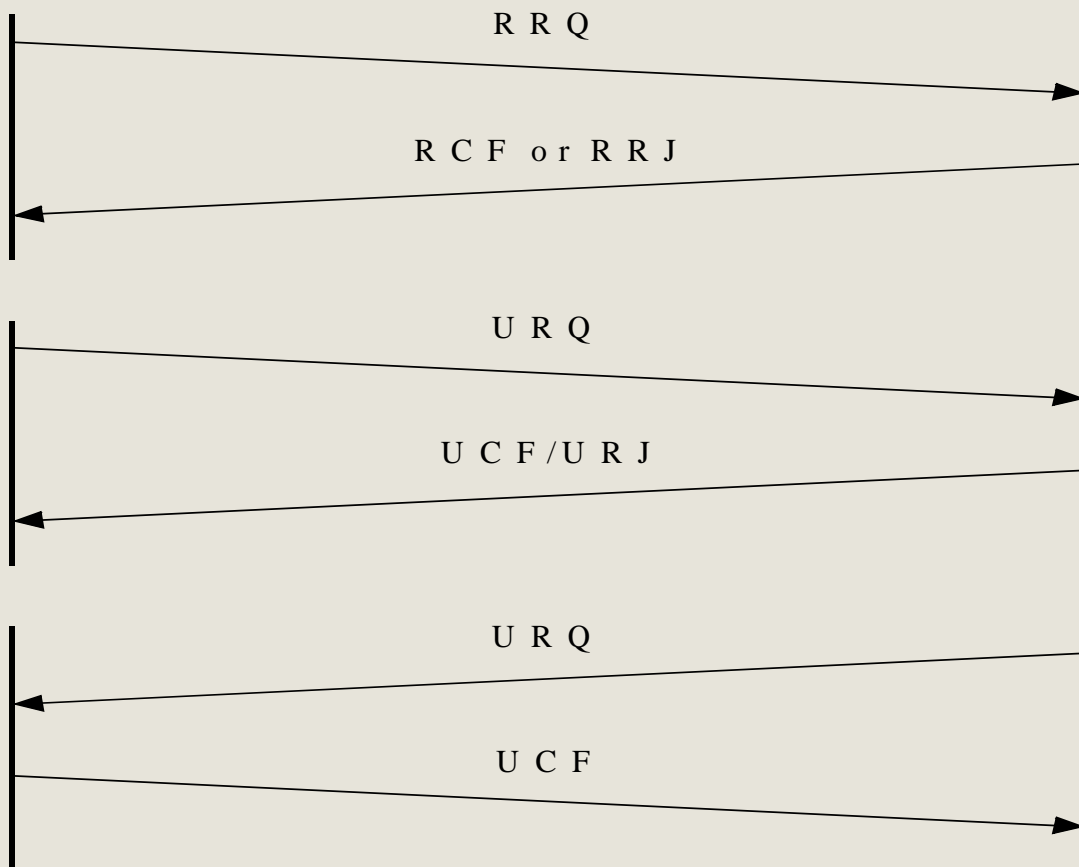

Endpoint initiated  
Unregister Request

Gatekeeper initiated  
Unregister Request

T 1524050-96



## H.323 signaling: Call Set Up (H.225)

### Key features

- ISUP signaling (Q.931) based
- ASN.1 based messages
- Transaction oriented protocol
- Signaling between end-points
  - Terminal or gateway  
and
  - Gatekeeper
- Use reliable channels

## RAS: Call set up - No gatekeeper ...

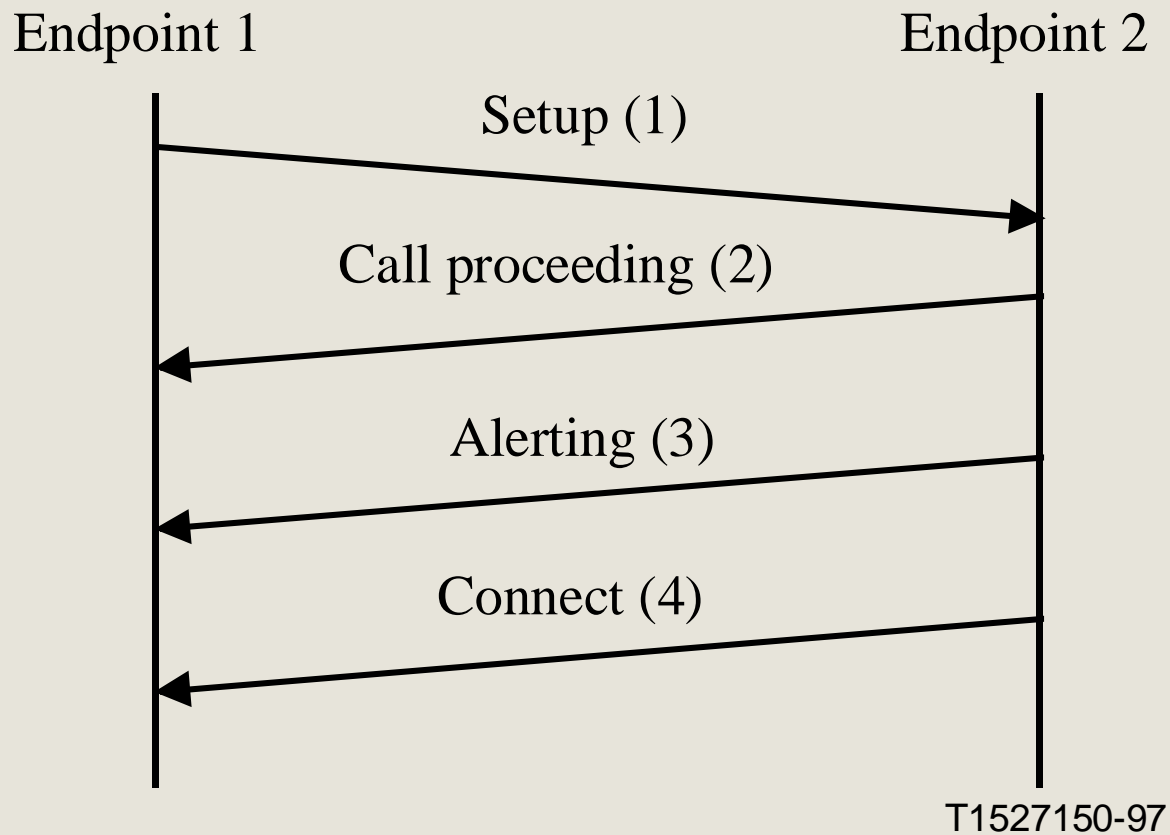

— Call Signalling Messages

# RAS: Call set up - 1 gatekeeper ...

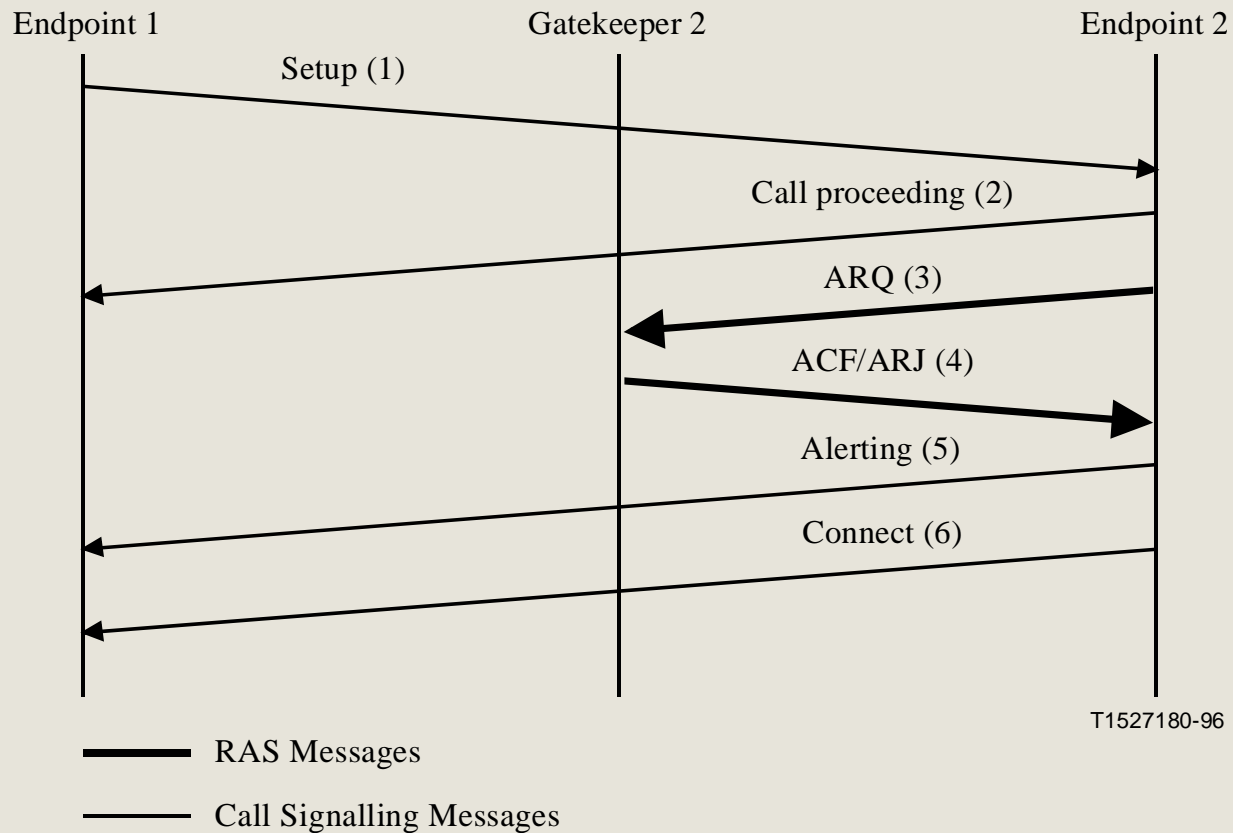

# RAS: Call set up - Two gatekeepers ...

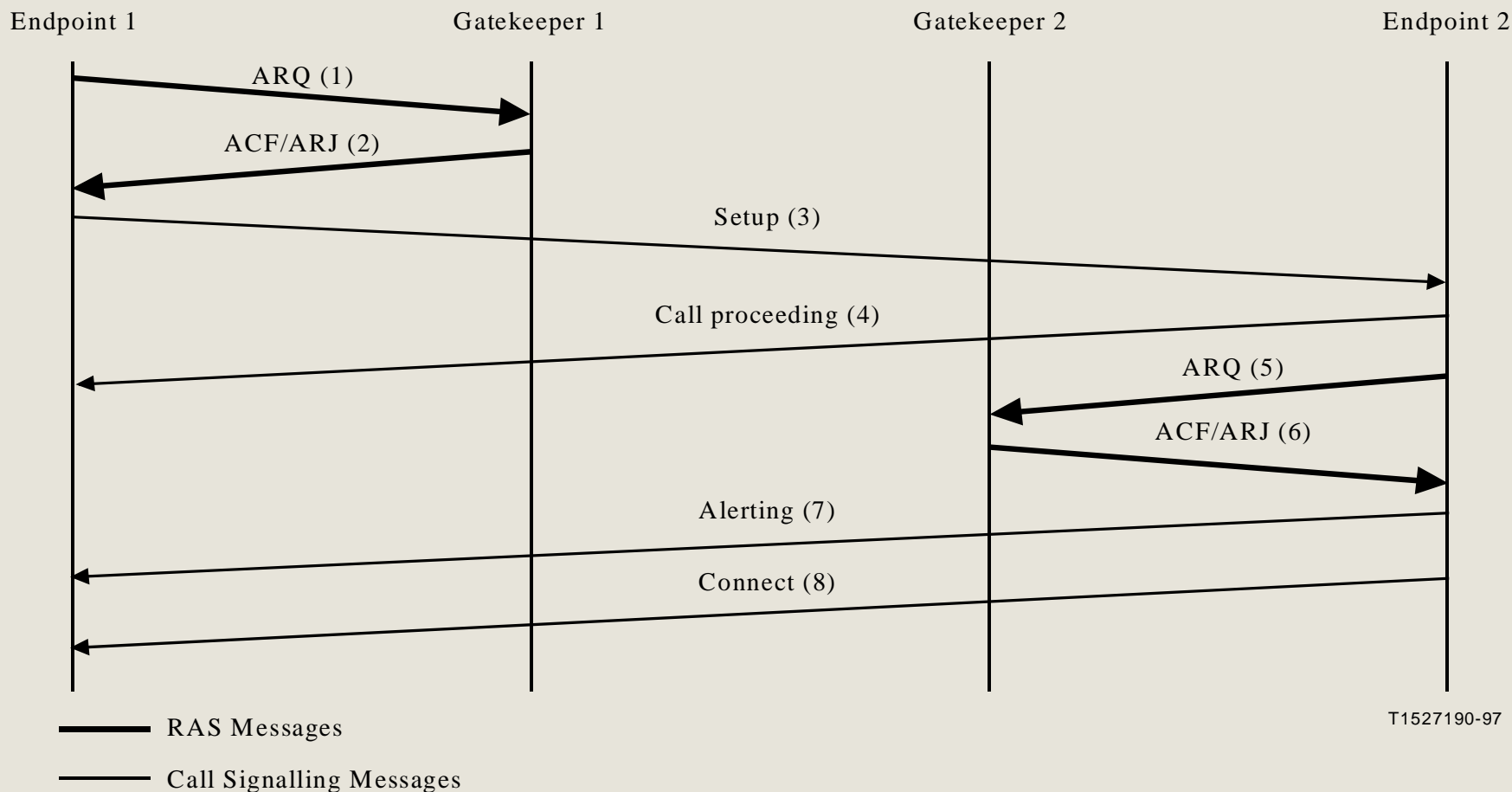

# H.323 signaling: Media signaling (H.245)

## Key features

- ASN.1 based messages for
  - Master/slave determination
  - Capabilities negotiation
  - Logical channel signaling
- Several modes
  - Request/reply
  - Commands
  - Indications
- Signaling between end-points
  - Terminal or gateway
  - and
  - Gatekeeper
- Use reliable channels

# H.323 signaling: Master / slave determination

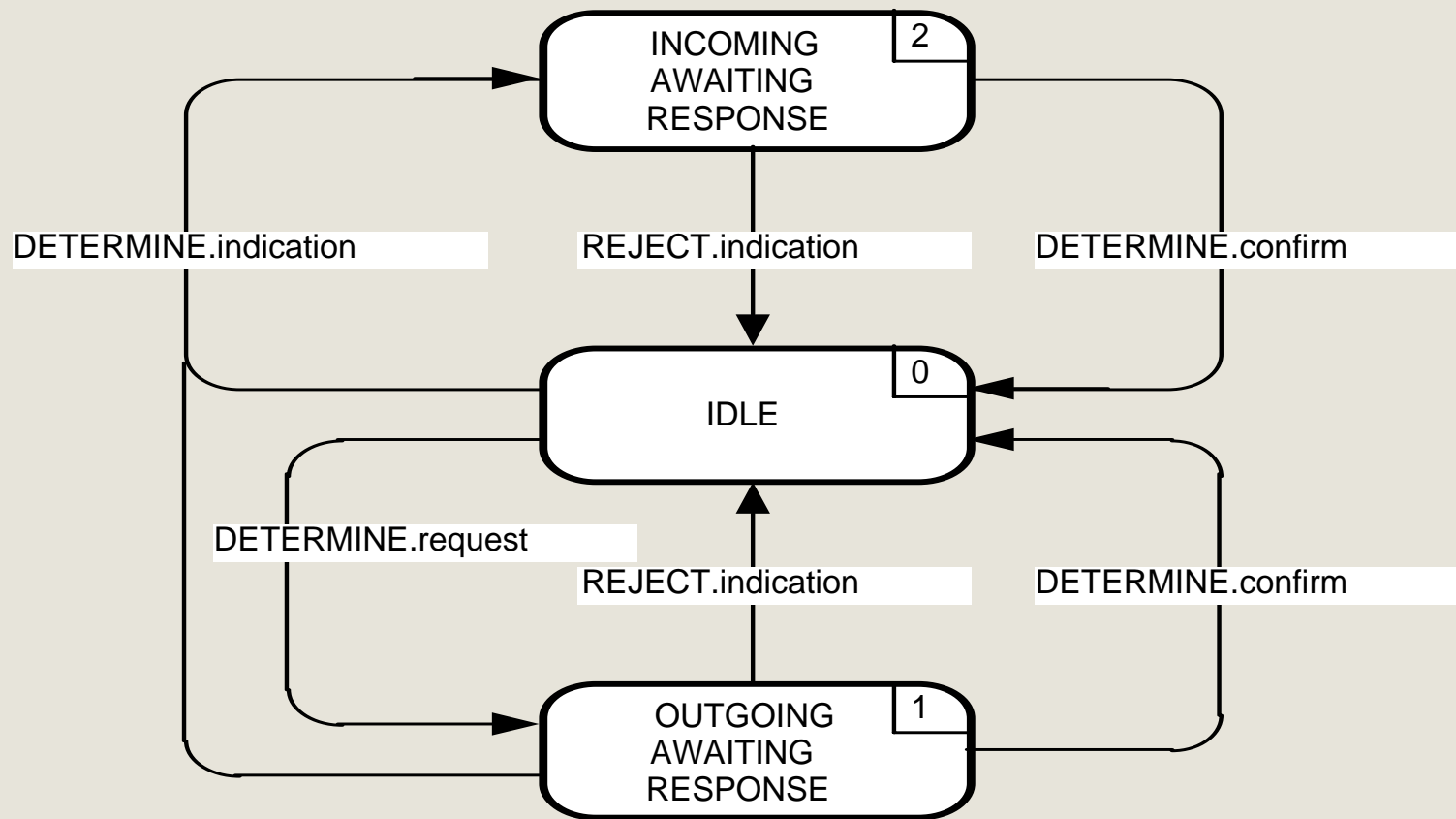

## H.323 signaling: Capabilities exchange

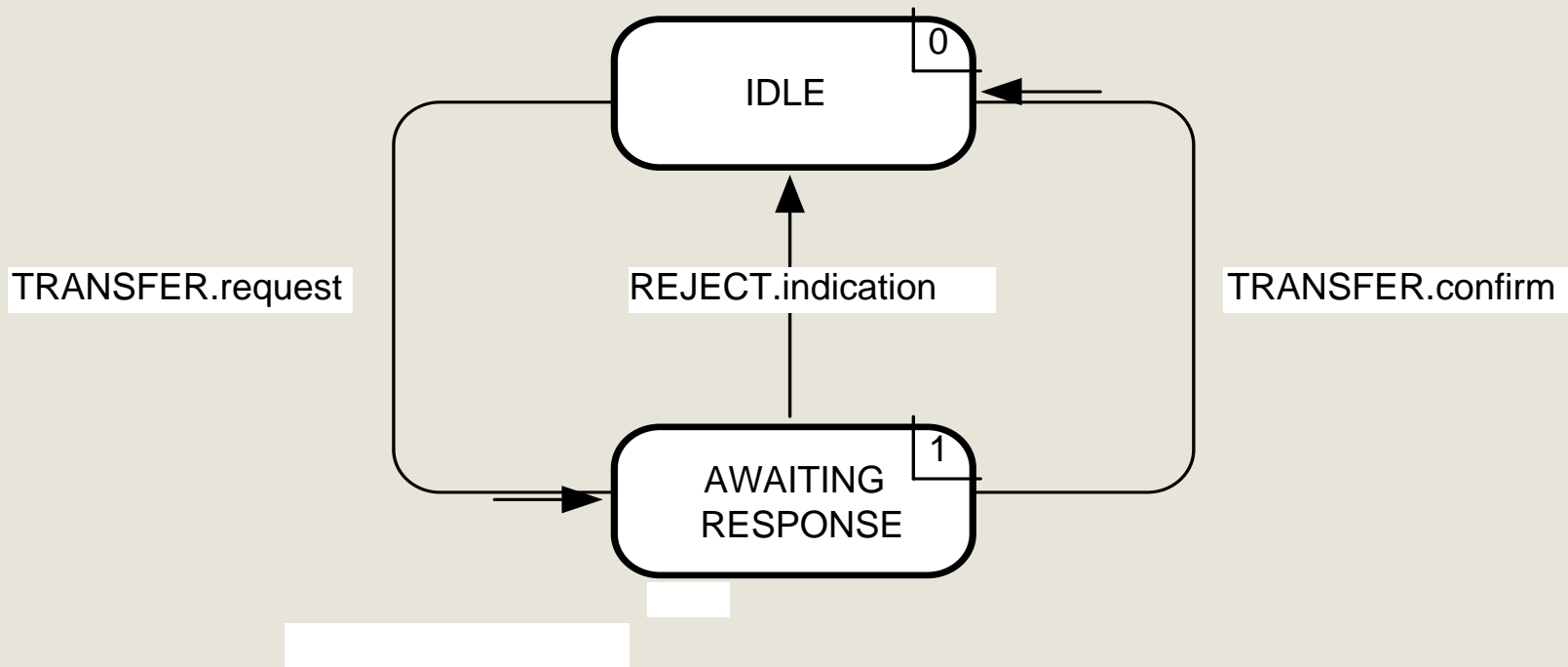

## H.323 signaling: Capabilities exchange

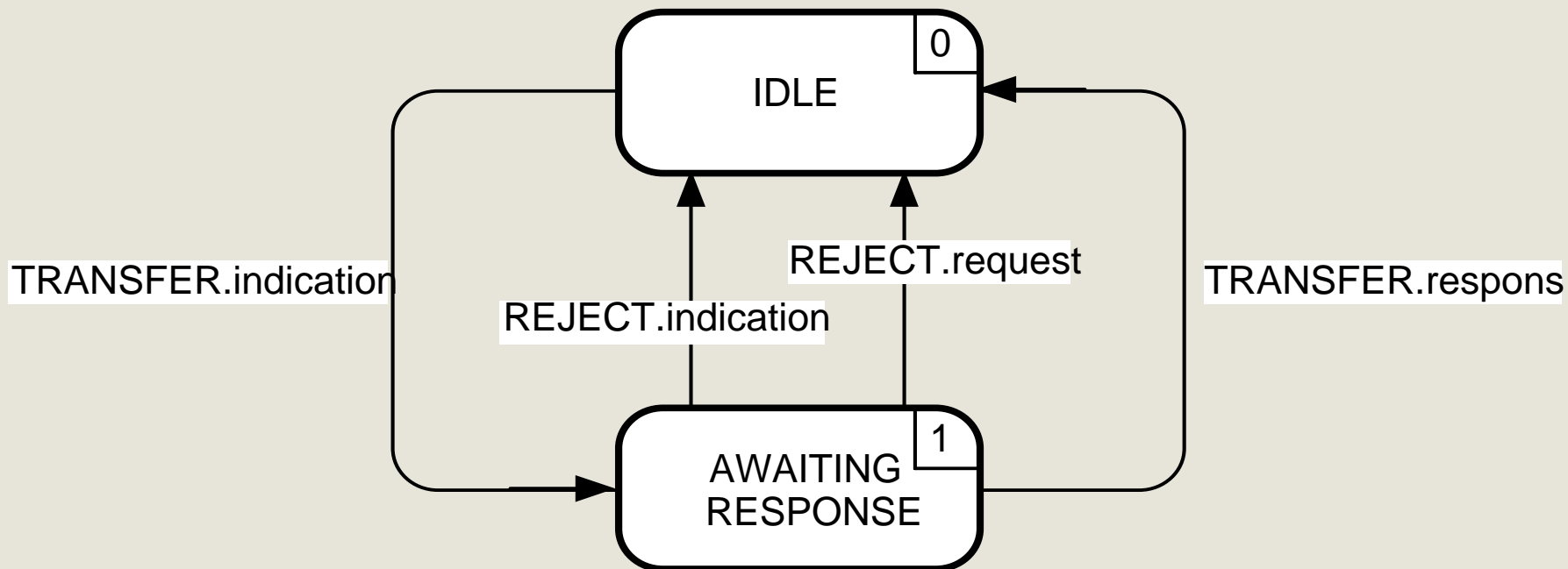



# H.323 signaling: Logical channels

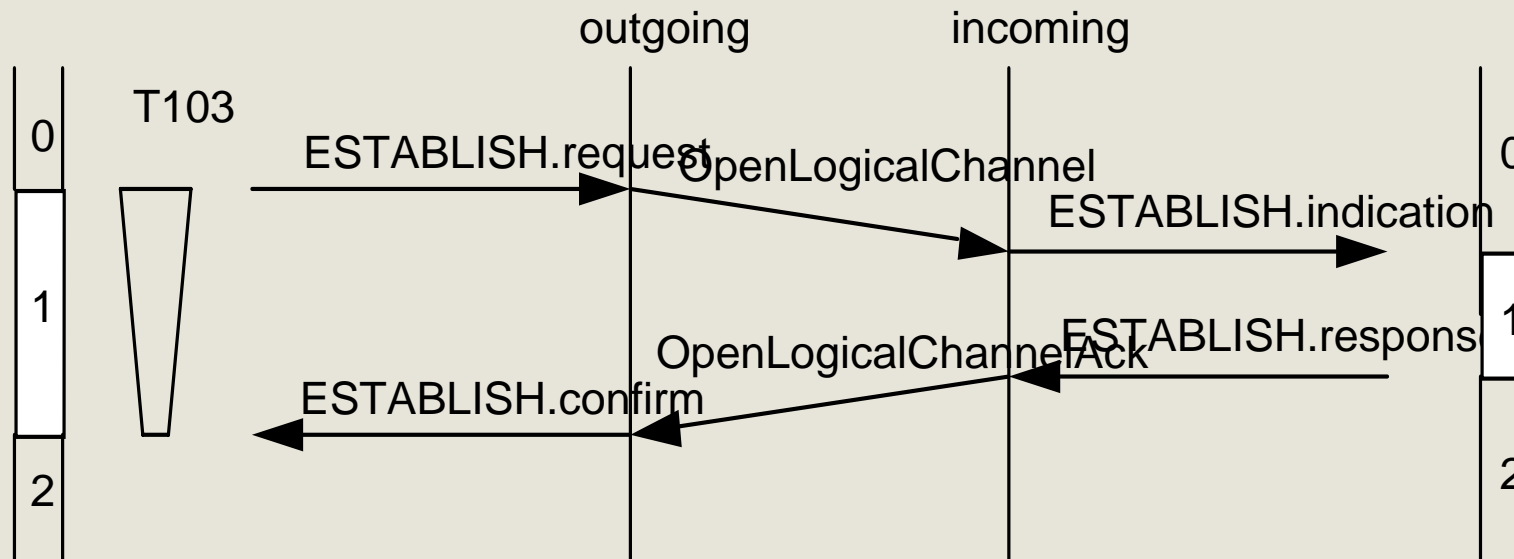

## H.323 signaling: Logical channels

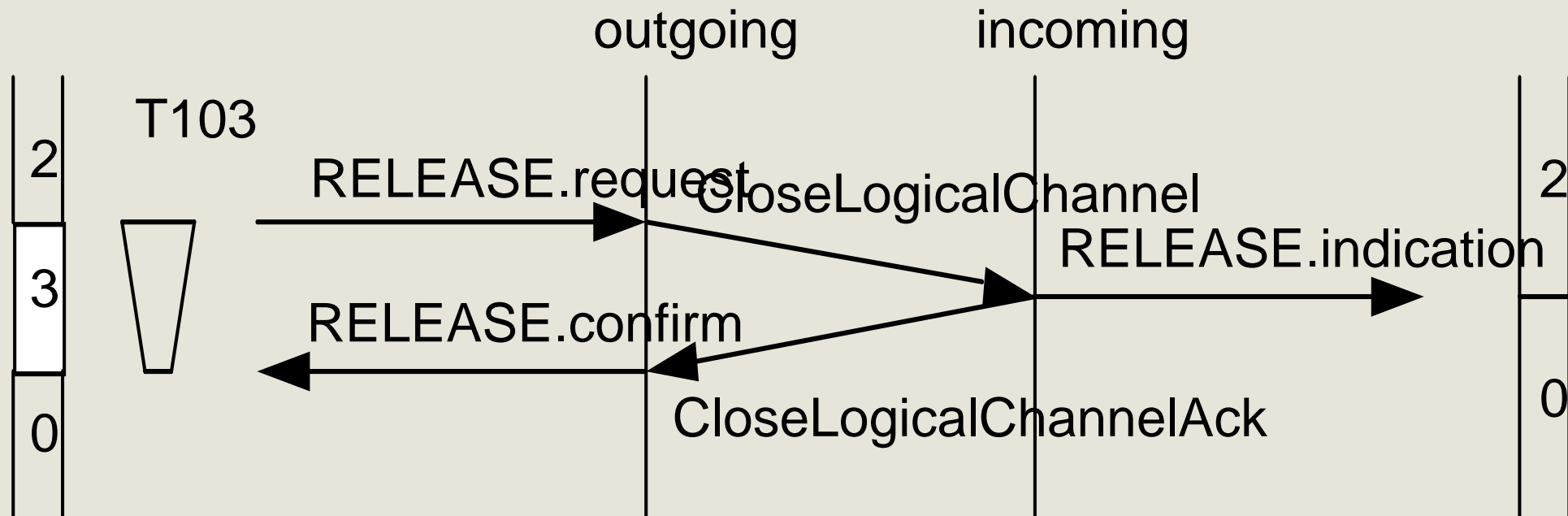

## H.323 signaling: An important feature - Fast connect

Introduced as an afterthought in H.323

Allow call set up and logical channel set up using a single message

- FASTCONNECT

- Include as parameter fast start to indicate that logical channel should be opened
- May be refused by the other end (Fast connect refused)

# H.323 signaling: Putting it together ... alternative 1

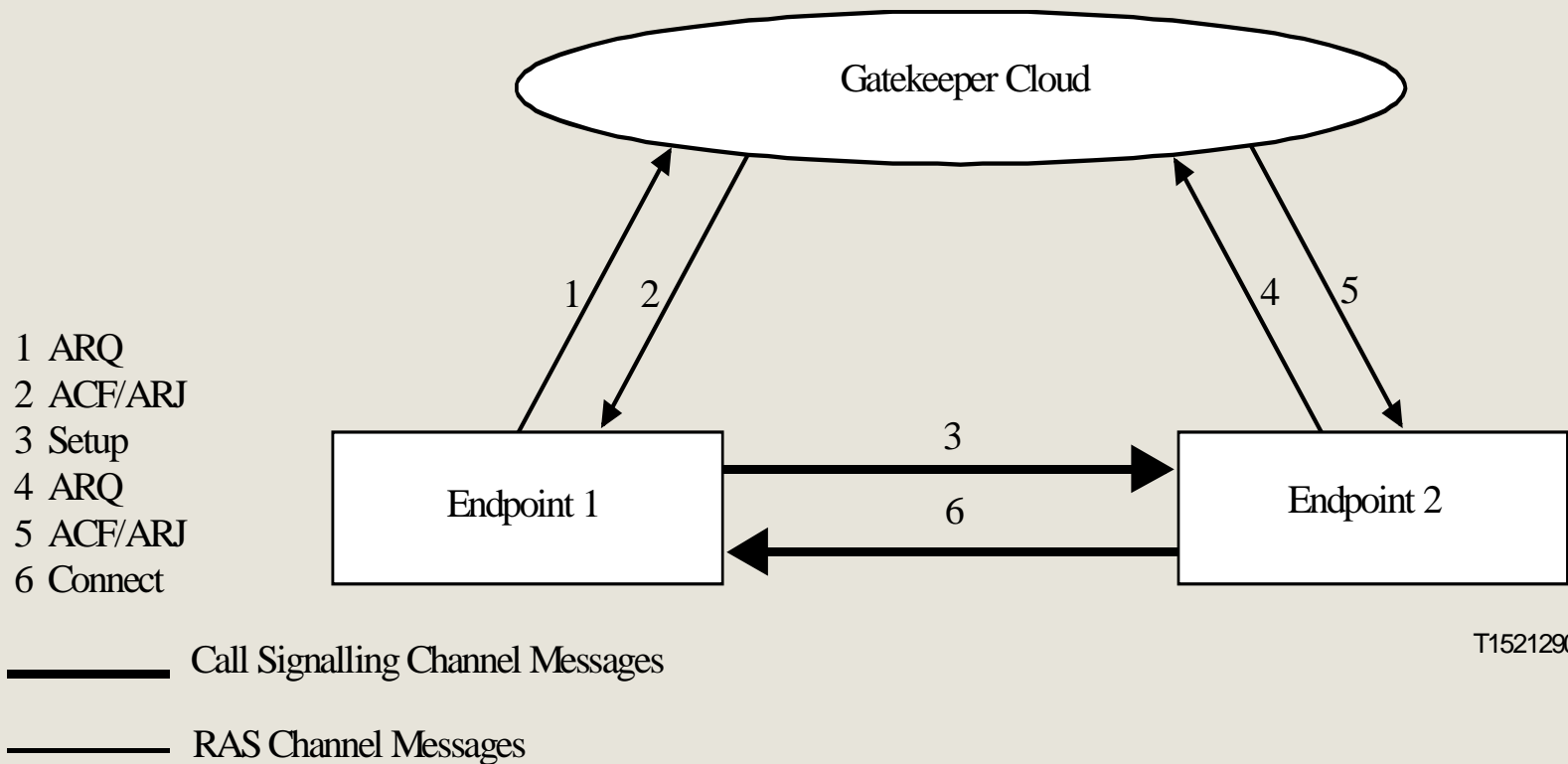



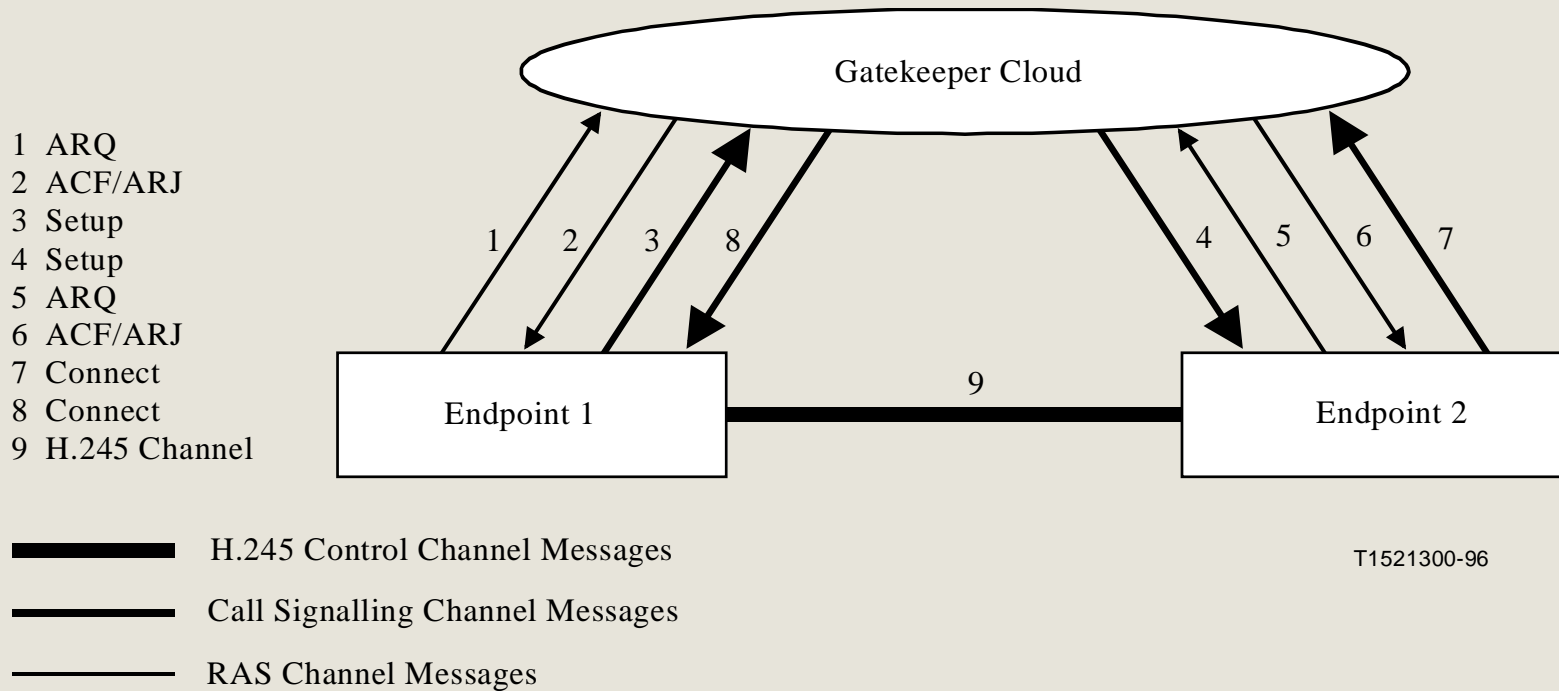

T1521290-96

# H.323 signaling : Putting it together ...alternative 2

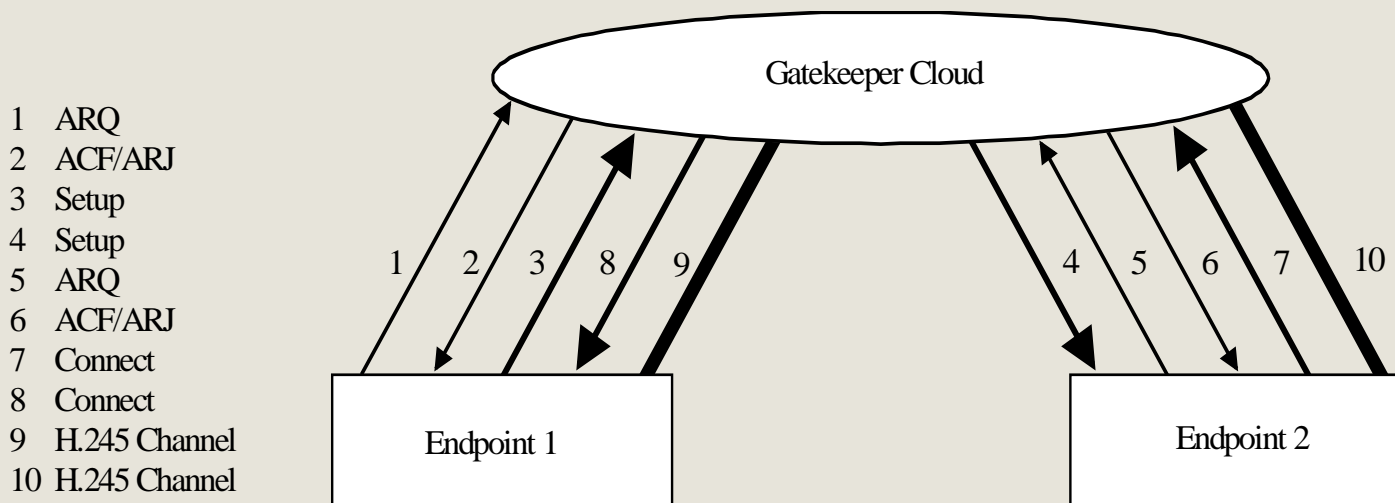

# H.323 signaling: Putting it together - alternative 3

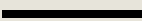

-  H.245 Control Channel Messages
-  Call Signalling Channel Messages
-  RAS Channel Messages

T1521310-96

# Megaco / H.248

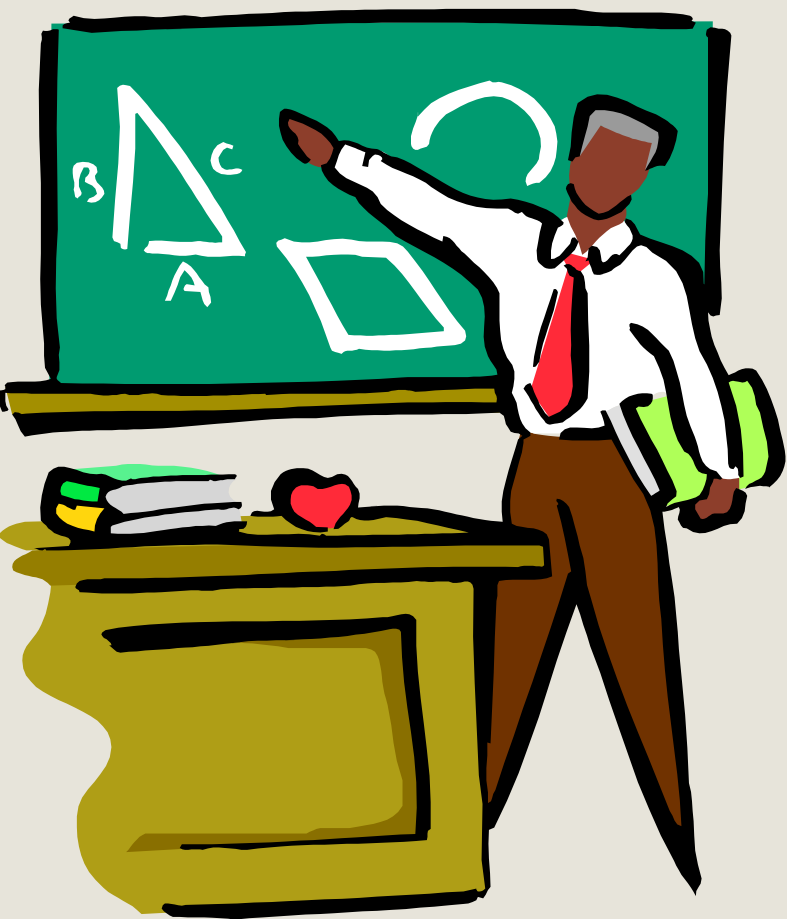

1. Introduction

2. Genesis

3. Concepts

4. Protocol

5. Call cases

## Megaco/H.248: Introduction

### Primary motives for decomposing gateways between PSTN and next generation networks:

- Scalability
- Specialization
- Opening up of market to new players

### Side-effect

- Possibility of using the part of the decomposed gateway for call control
  - Soft-switches



# Megaco/H.248 : Introduction

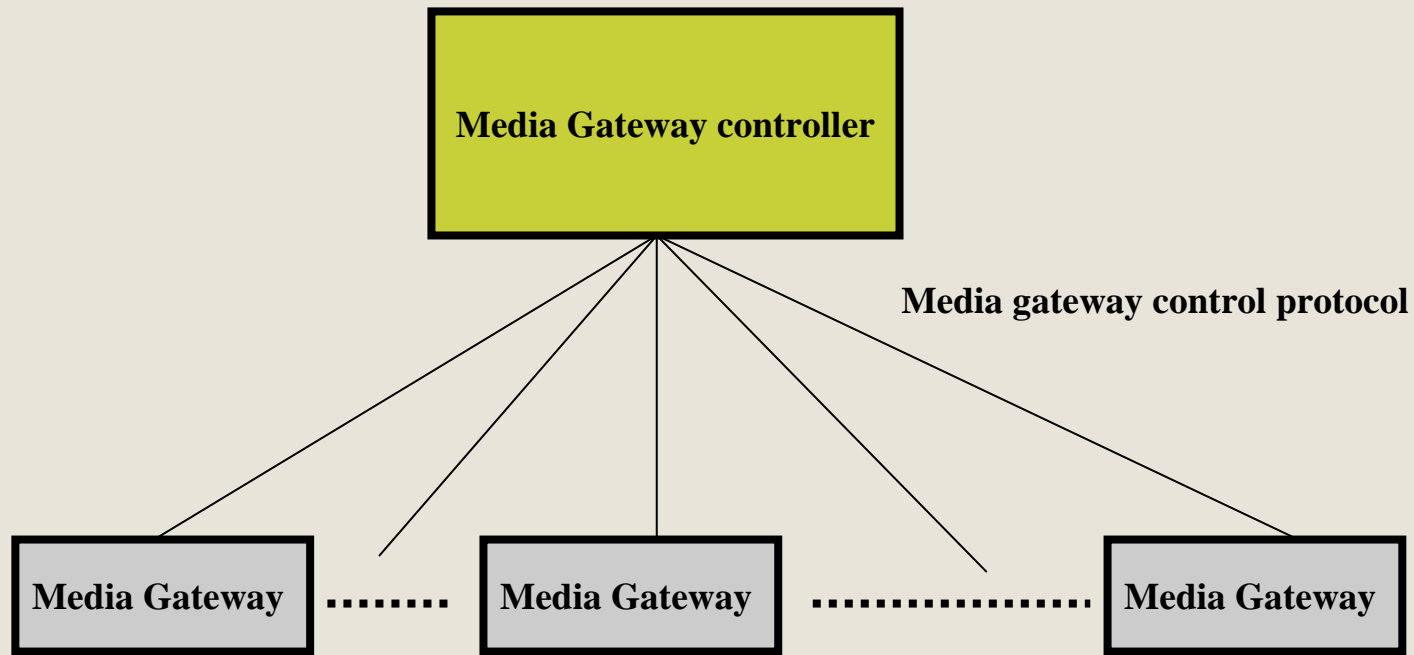

# Megaco/H.248: Genesis

A long history starting in 1998

- Simple Gateway Control Protocol (SGCP)
  - Text based encoding, limited command set
- IP Device Control Protocol (IPDCP)
  - A few more features to SGCP
- Media Gateway Control Protocol (MGCP)
  - Merge of SGCP and IPDC
- Media gateway Decomposition Control Protocol (MDCP)
  - Binary encoded
- Megaco / H.248 (Joint IETF / ITU-T specifications)
  - A compromise
    - Both text based and binary encoding
    - A wide range of transport protocols(e.g. UDP, TCP, SCTP)

# Megaco/H.248: Concepts - Termination

Source or sink of media

- Persistent (circuit switched) or ephemeral (e.g. RTP)
- IDs
  - Unique or wildcard mechanism (ALL or CHOOSE)
- Properties/descriptors
  - Unique ids
  - Default values
  - Categorization
    - Common (i.e. termination state properties) vs. stream specific
    - For each media stream
      - Local properties
      - Properties of received streams
      - Properties of transmitted streams
    - Mandatory vs. optional
      - Options are grouped in packages

# Megaco/H.248: Concepts - Termination

## Examples of properties/descriptors

- Streams
  - Single bidirectional stream
    - Local control: Send only – send/receive ...
    - Local: media received
    - Remote: media sent
- Events
  - To be detected by the MG and reported to the controller
    - On hook / Off hook transition
- Signals
  - To be applied to a termination by the MG
    - Tones
    - Announcements
- Digit map
  - Dialling plan residing in the MG
  - Detect and report events received on a termination ..

## Megaco/H.248: Concepts - Context

### Context (mixing bridge)

- Who can hear/see/talk to whom
- Association between terminations
- May imply
  - Conversion (RTP stream to PSTN PCM and vice versa)
  - Mixing (audio or video)
  - Null context
    - Terminations that are not associated with no other termination (e.g. idle circuit switched lines)
  - Topology
  - Precedence

## Megaco/H.248: Protocol - Commands

Add termination to a context

Modify the properties of a termination

Subtract a termination from a context

Move a termination from a context A to context B

Audit (values or capabilities)

Notify

ServiceChange (specific type of notify – terminations about to be taken out of service)

## Megaco/H.248: Protocol - Transactions

Possibility to send several commands in one go

- Transaction Request
- Transaction Reply
- Transaction pending

# Megaco/H.248: Protocol - Transportation

Several alternatives

An example

- UDP/IP
  - Unreliable, timeouts / resends
  - At most once functionality required (Receivers should keep track of received commands)



## Megaco/H.248: PSTN / NGN Interconnection ...

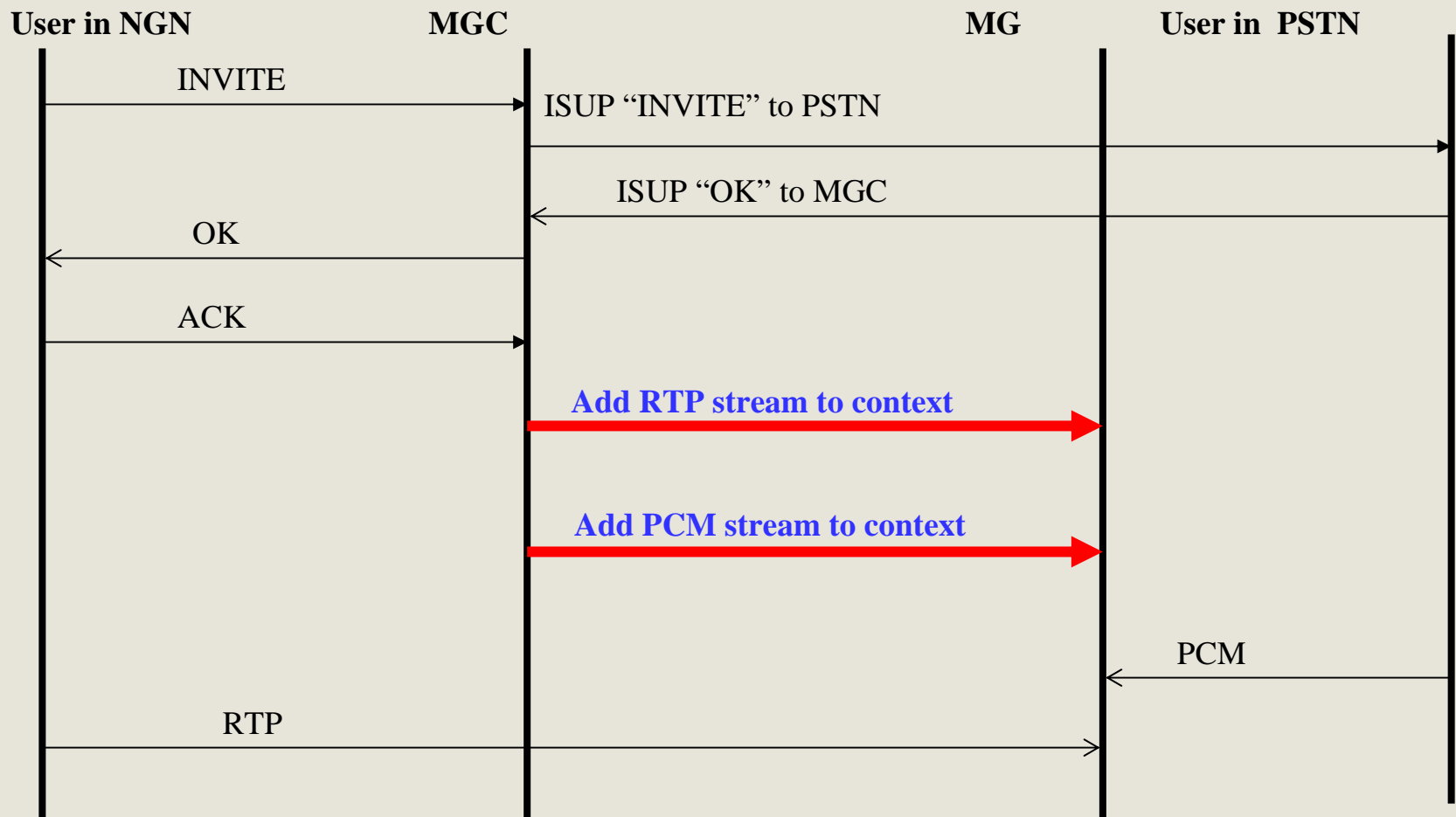

# Megaco/H.248: Conferencing ...

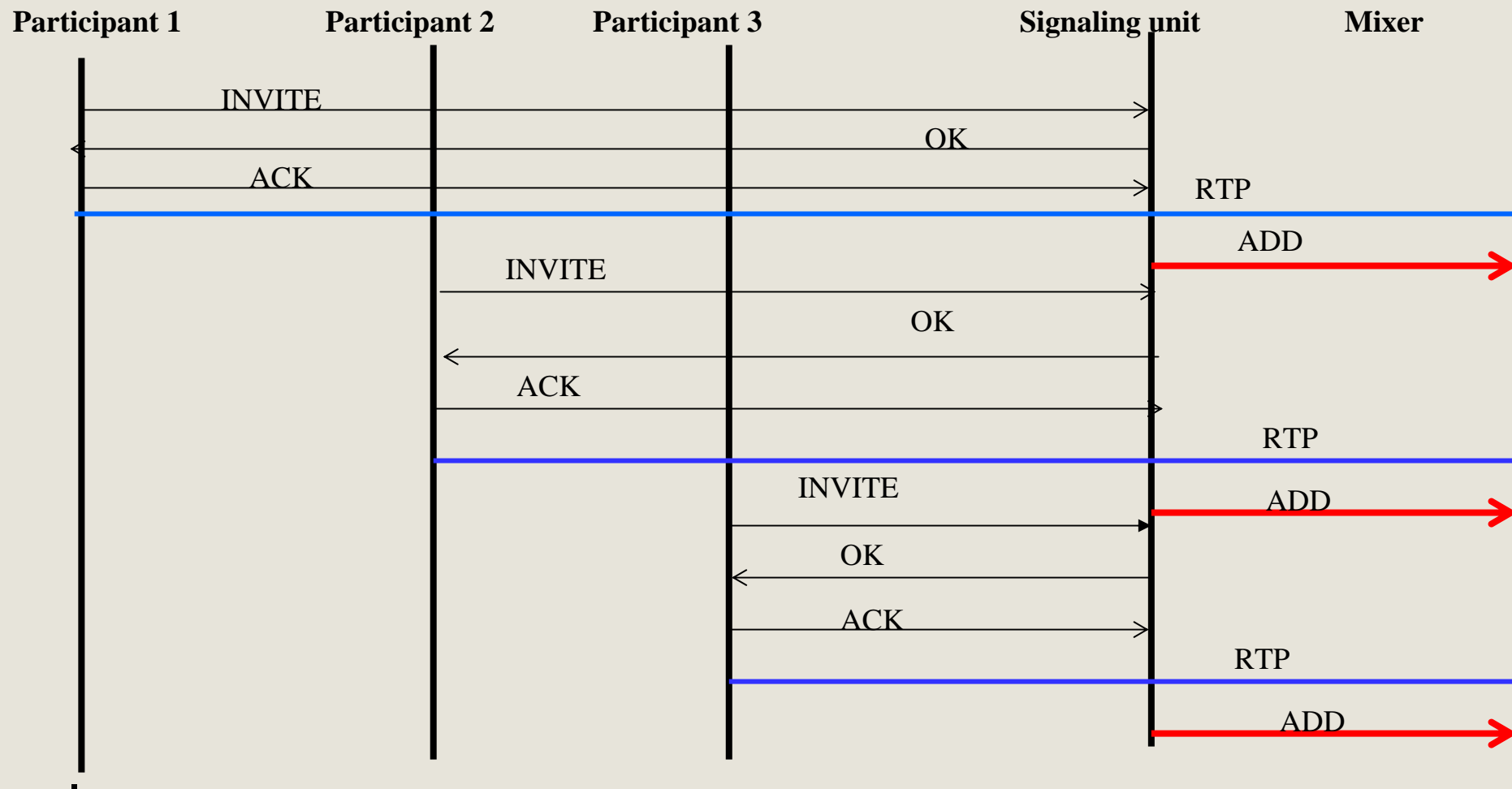

## Megaco/H.248: Megaco IP phones

Phone considered as a media gateway ...

- Terminations
  - User interface
  - Audio transducers
    - Hands free
    - Headset
    - Microphone
- Interactions
  - Add
  - Move
  - Subtract
  - Modify

# Soft-switches

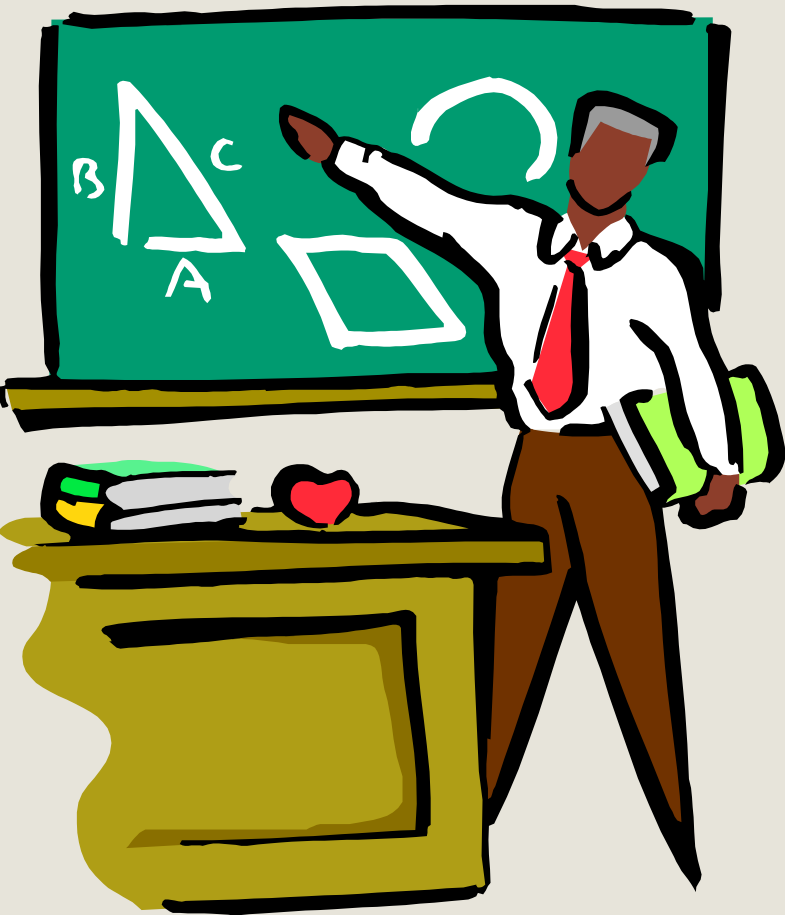

1. Introduction
2. Overview
3. A simplified call case

## Soft-switch: Introduction

### A “side effect” of media gateway decomposition

- Aggressively promoted by the soft-switch consortium, now known as the International Packet Communication Consortium (IPCC)
  - Adoption of existing standards (e.g. SIP, H.323, MGCP, Megaco)
- Gateway controller (plus some additional features) acts as a switch
  - Switching in software instead of hardware
- Can act as local exchange (class 5) or toll centre (class 4)
  - Lower entry costs for new incumbents
  - New local telephony networks and “by pass” for long distance call providers
- Soft-switches vs. classical switches debate
  - Scalability
  - Reliability
  - QoS

# Soft-switches : Overview

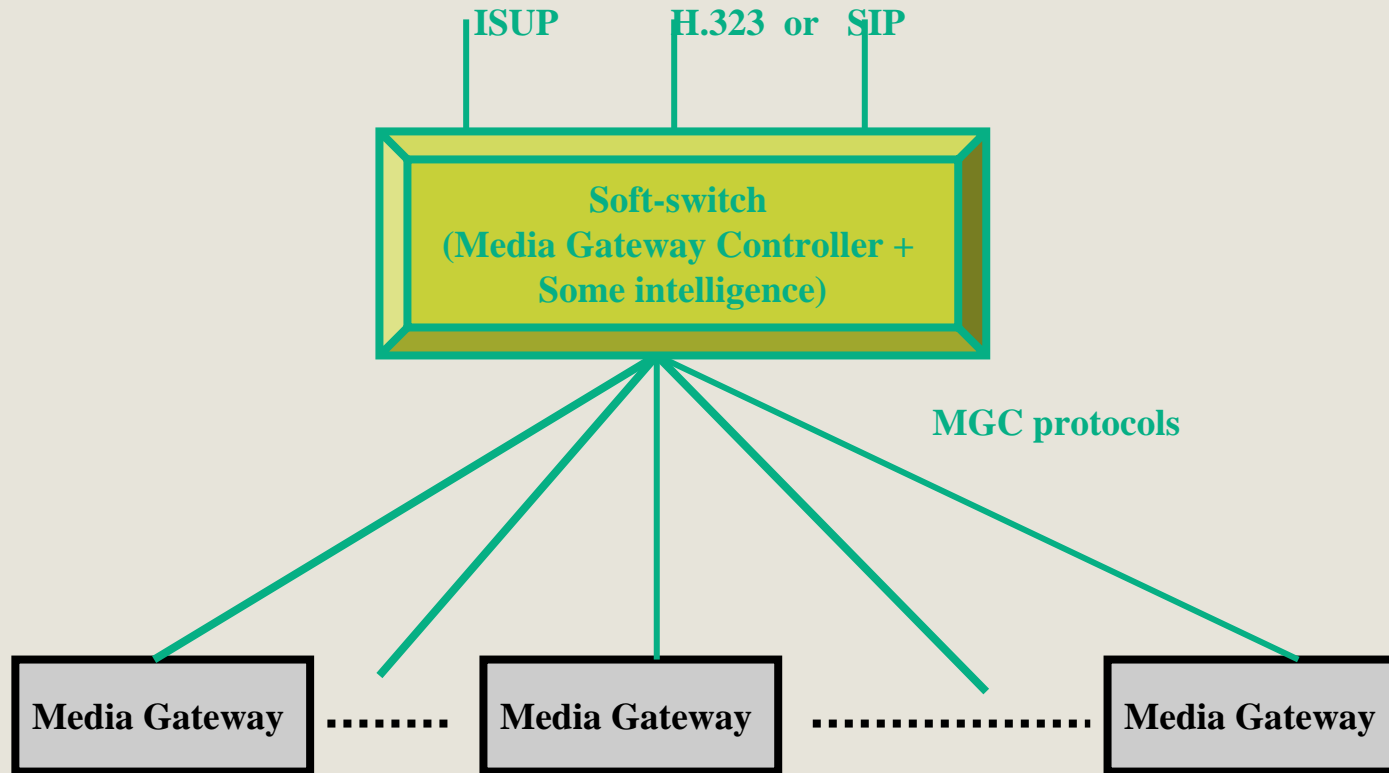

# Soft-switches : Overview

An example of soft-switch as class 5 replacement ...

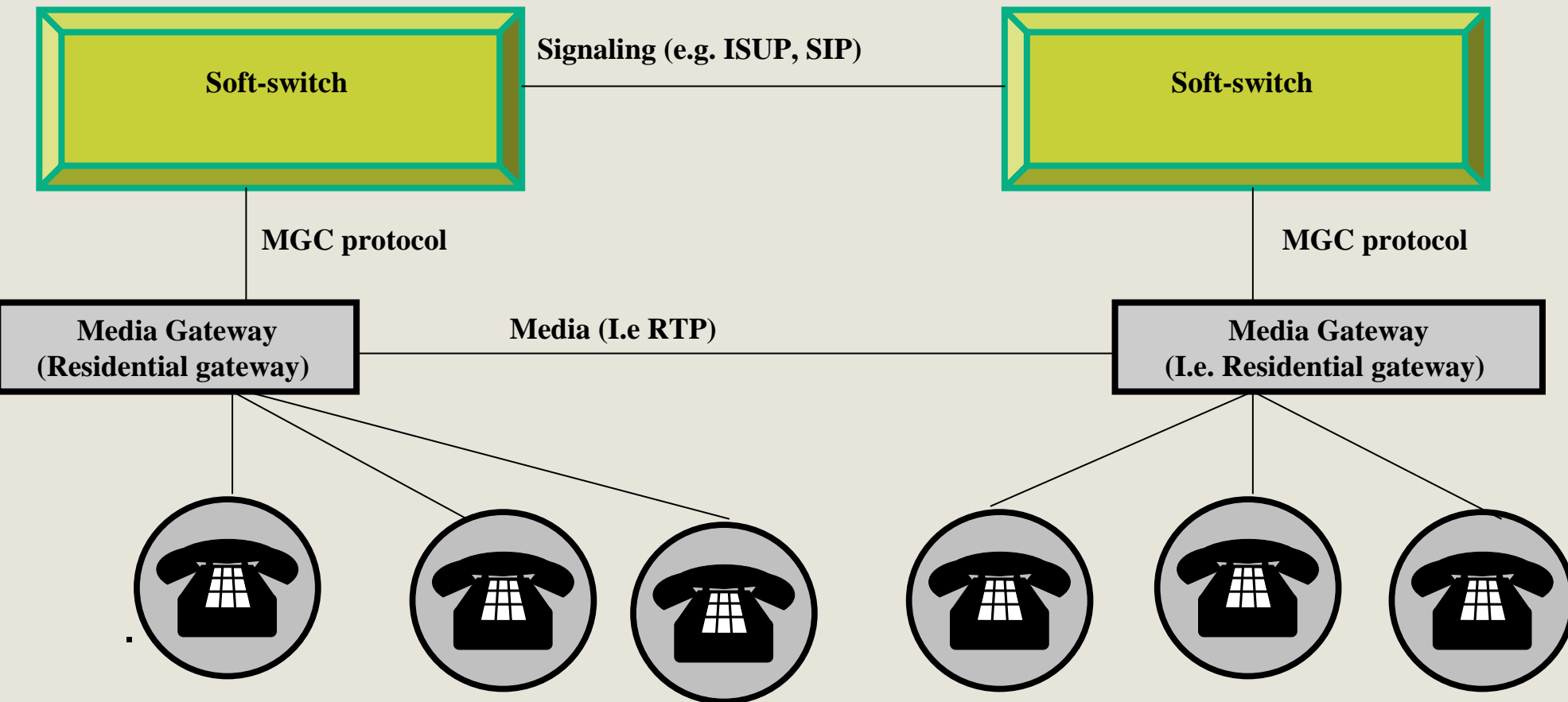

# Soft-switches : Overview

An example of soft-switch as class 4 replacement ...

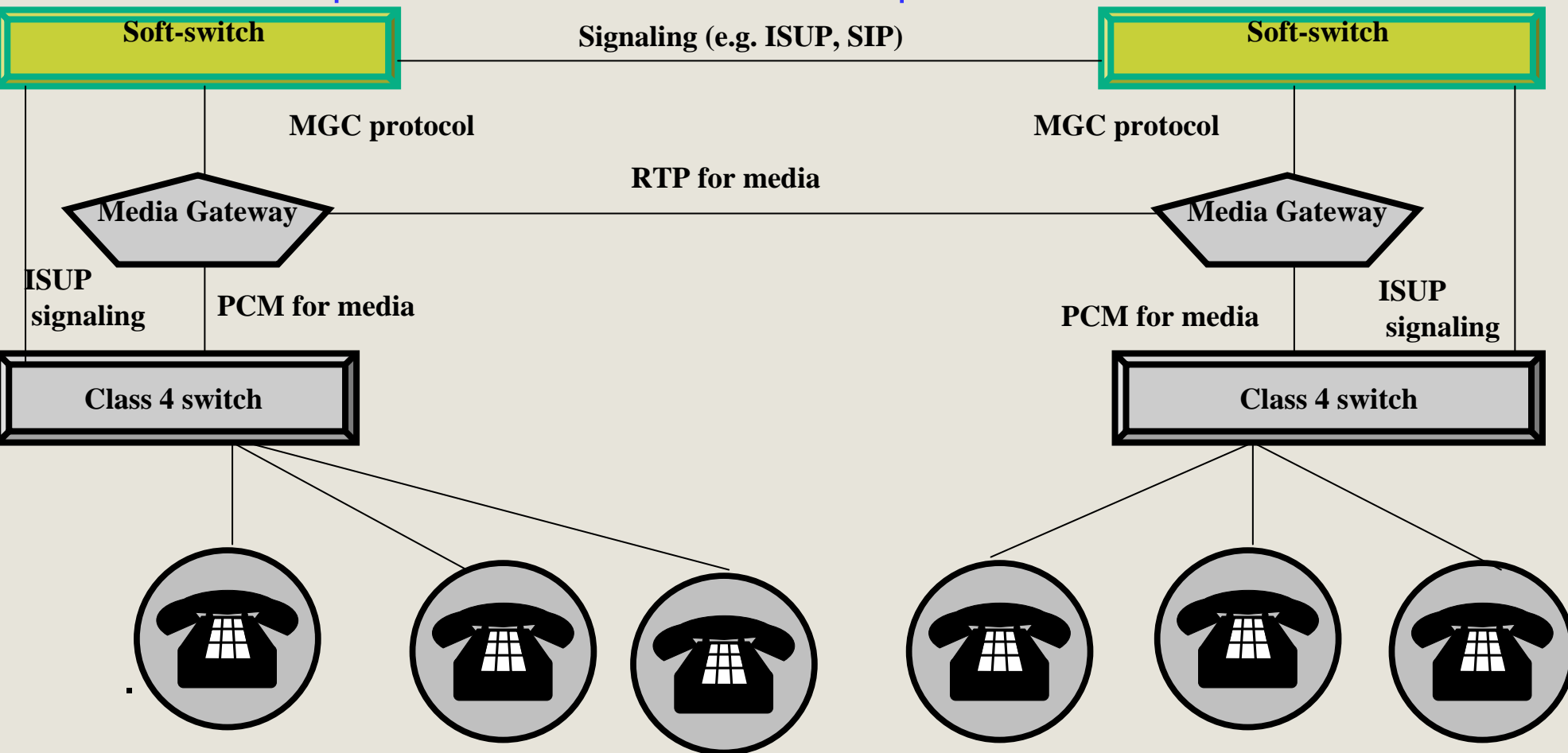



# Soft-switch: A simplified call case (Calling card)

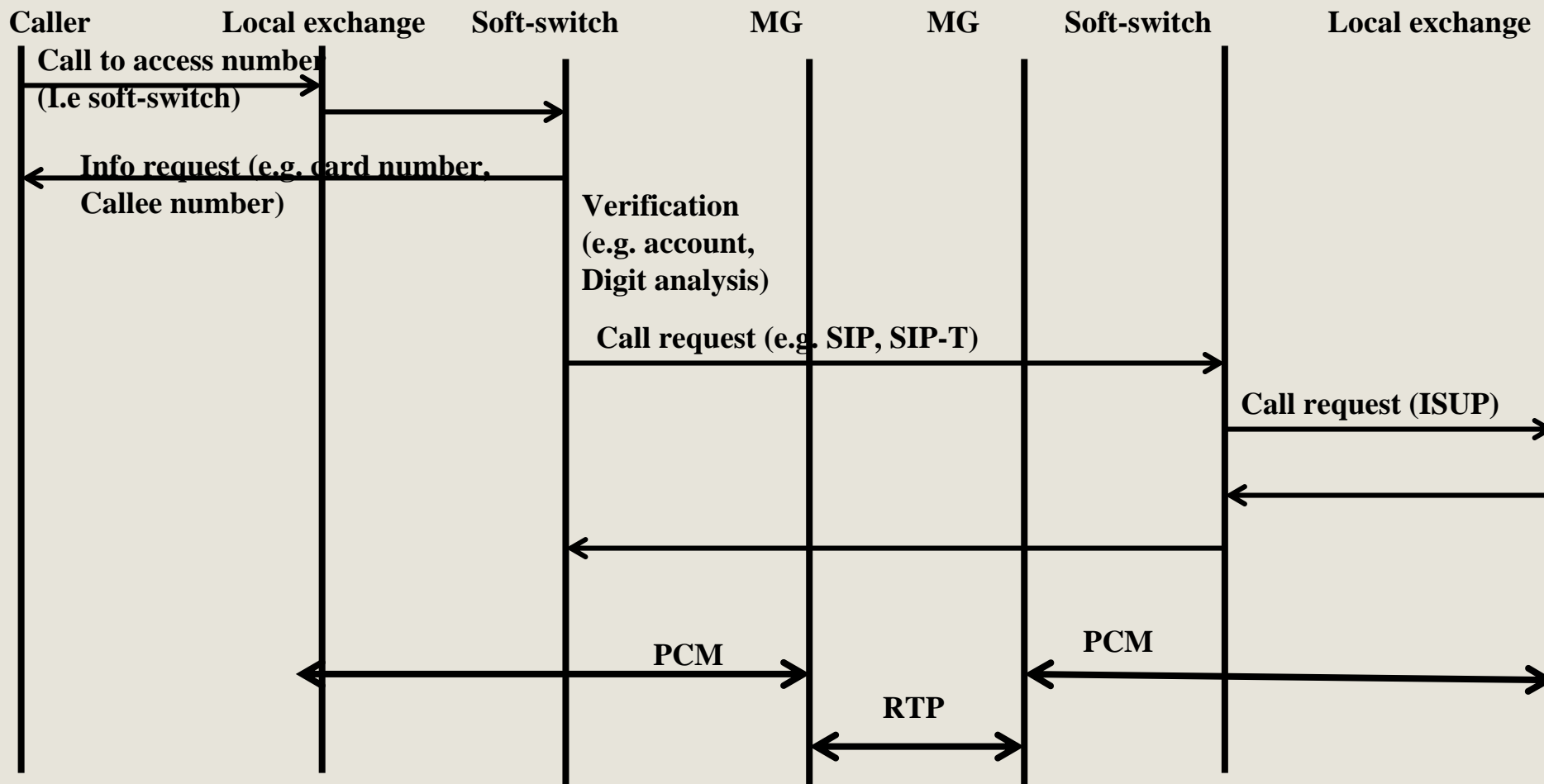

## References ...

1. Moderassi and S. Mohan, special issue, *Advanced Signaling and Control in Next Generation Networks*, IEEE Communications Magazine, October 2000 – Include papers on:
  - H.323
  - SIP
2. Additional references on Megaco/H.248
  - RFC 3525 (The protocol)
  - RFC 3054 (IP Phone)