



- **Week #9 (March 1 - 5)**
- **Quiz**
- **Week #10 (March 8-12)**
- **Parlay/OSA and CPL (Other examples of signaling protocol neutral service engineering technologies)**
- **Week #11 (March 15 - 19)**
- **QoS**
- **Week #12 (March 22 – 26)**
- **Web 2.0**
- **Week #13 (March 29 – April 2)**
- **UMTS and beyond**
- **Week #14 (April 5 - 9)**
- **Quiz**
- **Week #15 (April 12 – 16)**
- **Project reports + demos**



Chapter IX

Parlay/OSA and CPL as examples of signaling protocol neutral approaches



Introduction

Signaling protocol neutral service engineering technology

- Service architecture applicable to NGNs using any signalling protocol
 - Next Generation signalling protocols
 - SIP
 - H.323
- Example already studied in this course: Web services
- Examples presented today:
 - Parlay/OSA
 - Call Processing Language (CPL)
- Example to study later in the course:
 - Web 2.0



Signaling protocol neutral architectures ...



1. Parlay

2. CPL



OSA/PARLAY

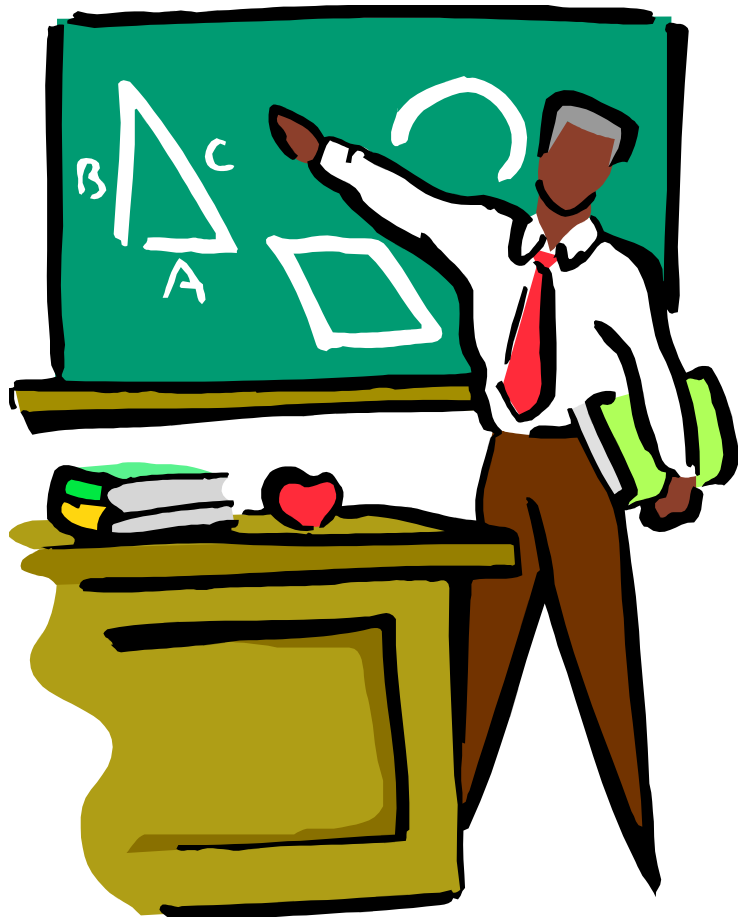

1. Introduction
2. Business model
3. Interactions
4. APIs
5. Case Study
6. Pros and cons



Introduction

PARLAY forum

- Created in 1998 as close forum
- Open since 2000
- Include most major players from telecommunications and computer industries (e.g. Ericsson, Lucent, Siemens, IBM)
- Work initially done in collaboration with third generation partnership project (3GPP)
- API called Parlay / Open Service Access (OSA)
- Parlay forum now dismantled and work fully done in 3GPP



Introduction

PARLAY main goal: Open up telecommunication networks

- Enable new business models
- Use open information technology middleware
- Make telecommunication network capabilities available for application development
 - Two types of APIs
 - Services APIs
 - Expose the network capabilities (e.g. call control, presence)
 - Framework APIs
 - Make the use of the service APIs secure, accountable and resilient (e.g. security, registration, authentication)



The business model

- Introduction
 - TINA-C inspired business model
 - Terminology: Services mean network capabilities
- Roles
 - Client application
 - Consume/use the services (e.g. network capabilities)
 - Equivalent to end users in TINA-C.
 - Enterprise operator
 - The entity that subscribes to the services
 - Subscriber in TINA-C
 - Framework operator
 - Entity that handles the subscriptions
 - Equivalent to the retailer in TINA-C



General model

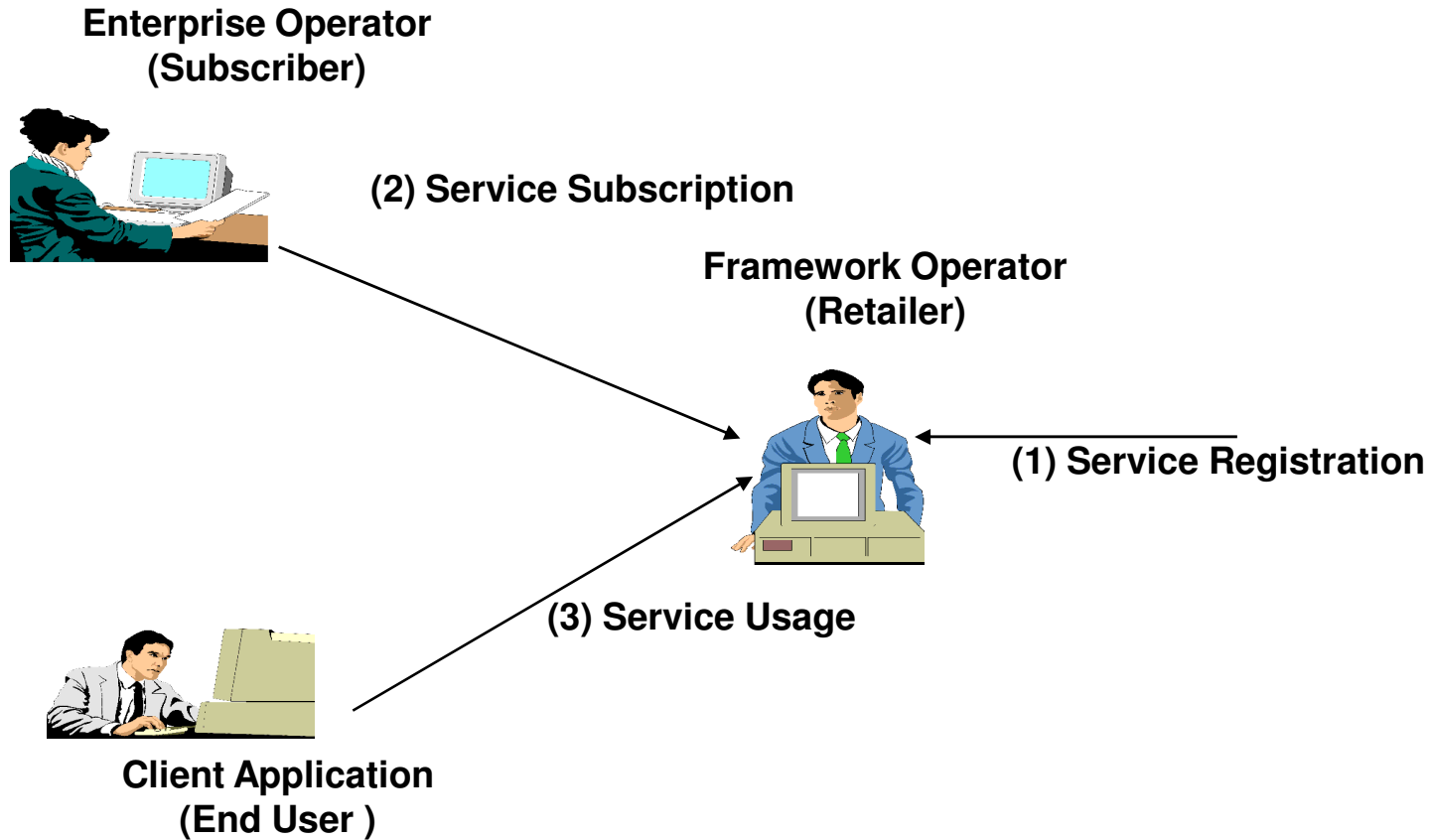



Commonly deployed model ...

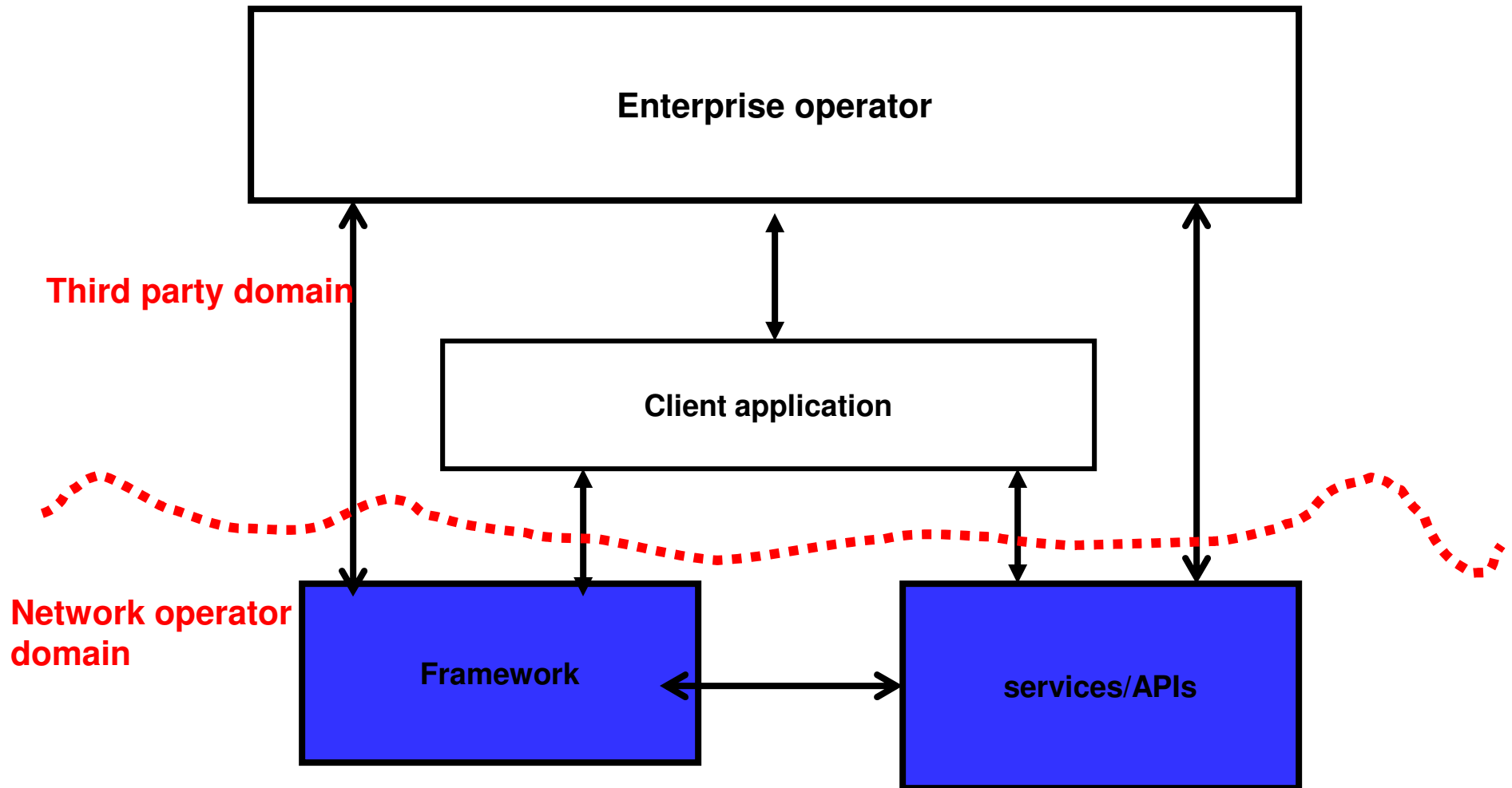



Interactions

Application and framework

Authentication

- Peer to peer model
- Allow framework to check that application is “who” it claims to be and application to check that framework is “who” it claims to be
- Usually used in only one direction (I.e. framework checking).

Authorisation

- Determination of what the application can do once authenticated

Discovery

- Once authenticated applications can get info on available APIs

Establishment of service level agreement

- . Usually done off-line



Interactions

Services/APIs and framework

Registration / De-registration

- Allow services to register/de-register to/from the framework



Interactions (Taken from reference [2])

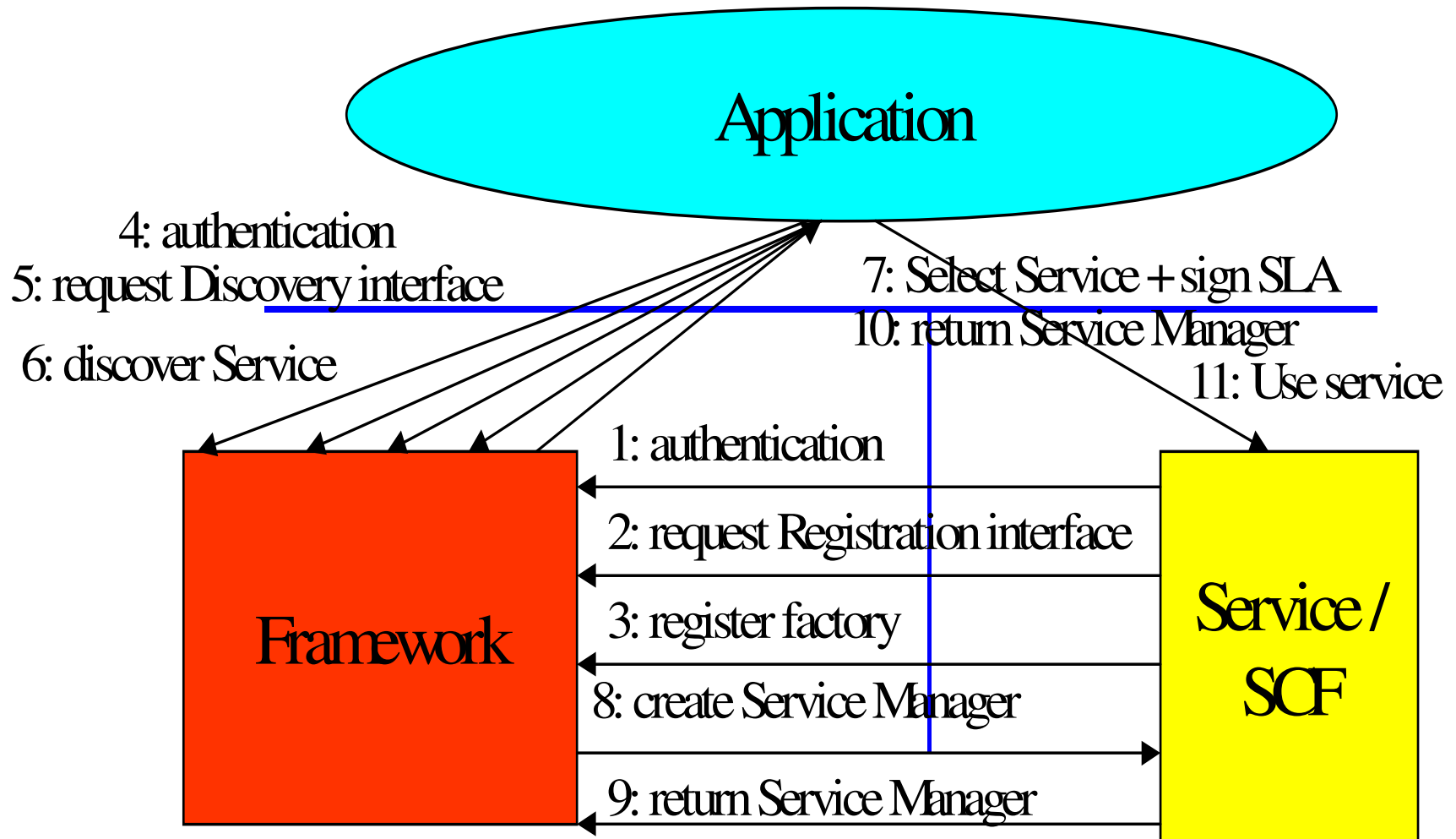

1 – 3 registration/discovery, 4-11 run time communications establishment



The APIs

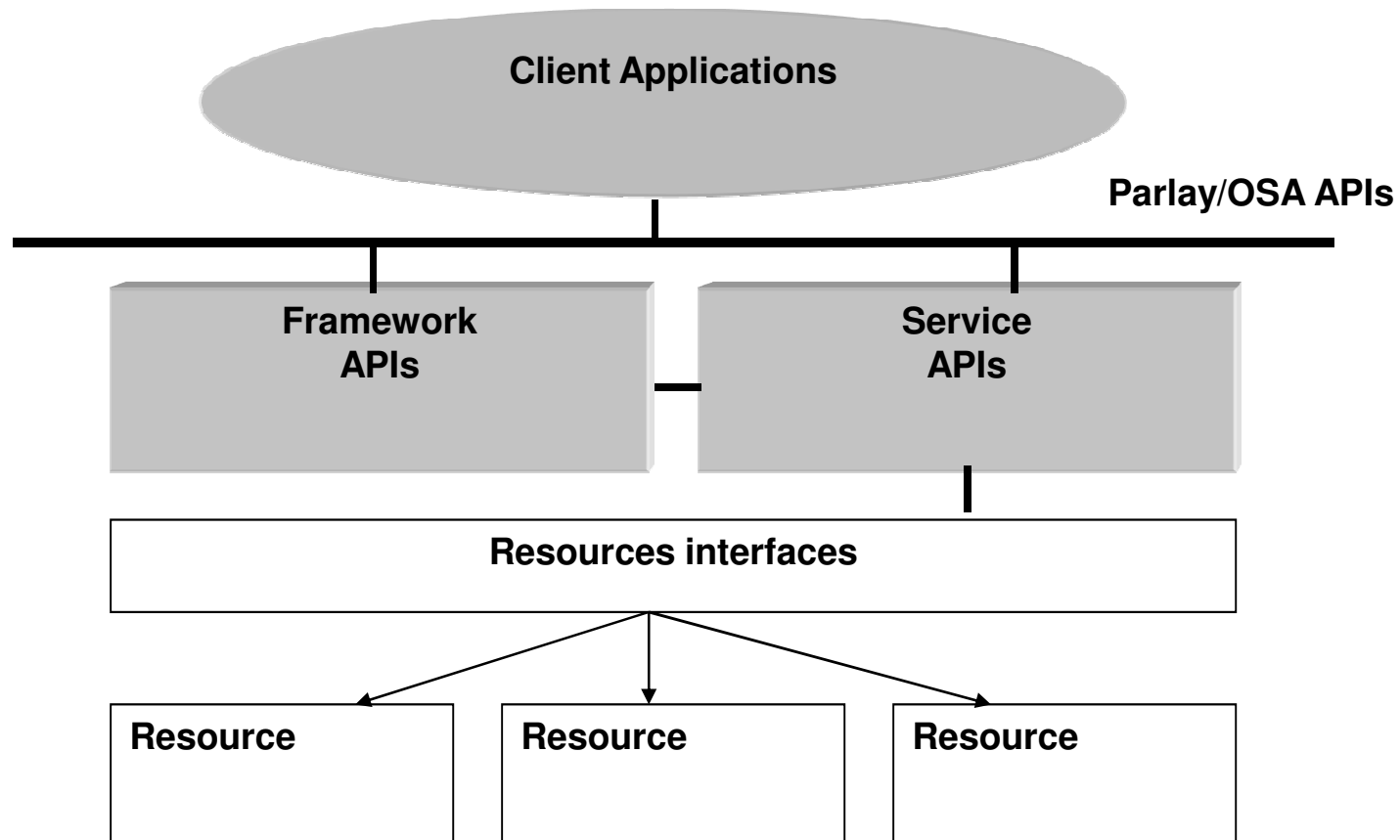

Figure 2 Parlay APIs interfaces



The APIs

Some common characteristics

Specifications include

- High level specification in UML (Universal Modelling Language)
- API specifications for several IT technologies
 - CORBA IDL
 - WSDL
 - Java

Two modes of communications

- Synchronous
- Asynchronous



Framework API: Make the use of the service APIs secure and resilient

Trust and security management

Event notification

Service discovery

Service registration

Integrity management (e.g. load management)

Service agreement



Framework API: Make the use of the service APIs secure and resilient

Trust and security management – Examples of method

AbortAuthentication ()

AuthenticationSucceeded ()

Challenge ()

TerminateAccess ()

InitiateAuthenticationWithVersion ()



Service API: Give access to network capabilities

Call control

User interactions

Generic messaging

Mobility

Terminal capabilities

Connectivity management

Account management

Charging service

Data session control

Presence and availability management



An example of Service API: Call control

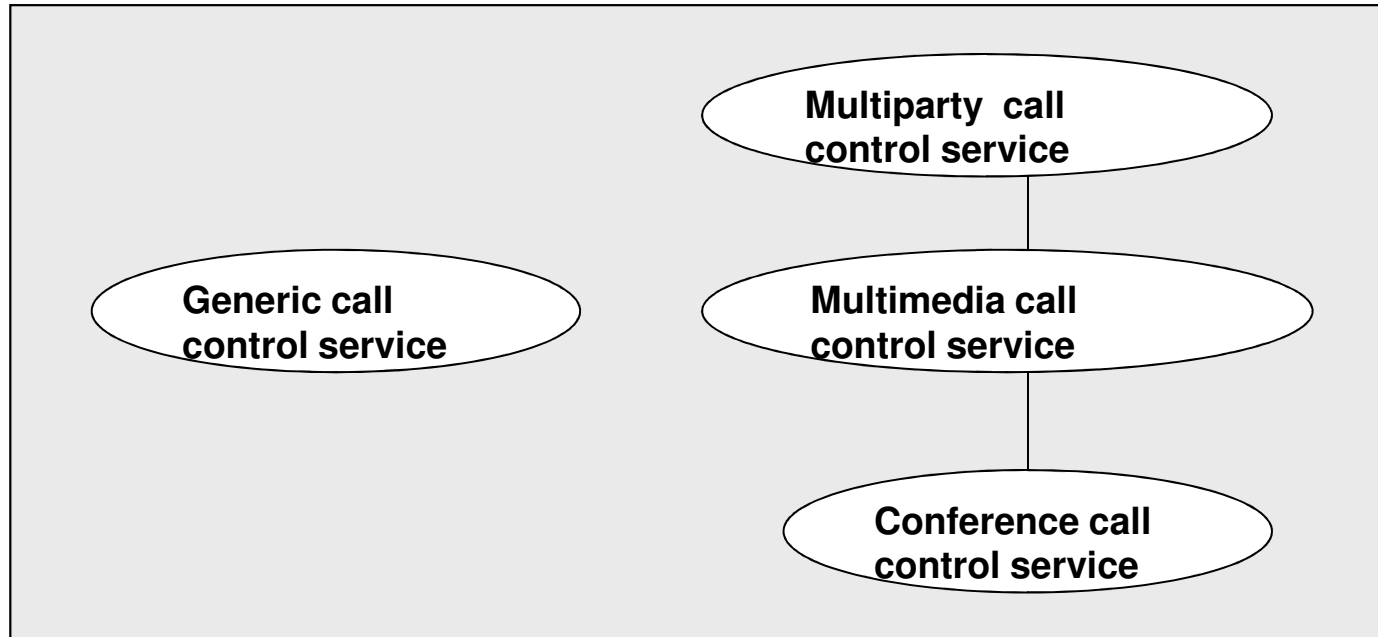



The call control API

Call model

- Terminal
 - End point (Not covered in the current specifications)
- Address
 - Represents a party in a call (E.164 number, IP address)
- Call
 - Abstraction of the physical call that occurs in a network
- Call leg
 - Logical association between a call and a party involved in a call



The call control API

Generic call control

- Two party voice call only
- Remain in Parlay for historical reasons

Multiparty call control

- Establishment of calls with any given number of users
- Root of the inheritance tree

Multimedia call control

- Add multimedia (e.g. media negotiation) capabilities

Conference call control

- Add conferencing capabilities



Conferencing / multiparty sessions

Basis of a wide range of applications

- Voice/videoconferencing
- Multiparty gaming
- Distance learning
- And more ...

Categorization schemes

- With / without sub-conferences
- Pre-arranged vs. ad hoc
- With / without floor control
 - Floor control: Who can be heard /seen
- Where the media is mixed (e.g Centralized vs. decentralized)
- Dial-in (Meet-me) vs. dial-out



Conferencing with Parlay

Examples of methods ...

- CreateConference ()
 - Parameters include the number of sub-conferences
- CheckResource ()
- ReserveResources ()
- FreeResources ()
- PartyJoined ()
- SplitSubconference ()
- MergeSubconference ()
- FloorRequest ()



A case study on PARLAY/OSA and SIP: Run For Your Life game (Described in detail in reference [3])



- 1 - Introduction
- 2 - Game
- 3 - Architecture
- 4 - Mapping



Introduction ...

Run-For-Your-Life

- Built from scratch in Ericsson Research lab in Montreal Canada
- Demonstrated at several trade shows (e.g. ICIN 2001, Parlay Munich meeting, Parlay Hong Kong meeting)
- Objectives assigned to the game design
 - Extensive usage of call control capabilities
 - Have fun ...



Introduction ...

Objective of the case study ...

Aim at helping in tackling two issues:

1. PARLAY Call Control APIs that cannot be mapped onto SIP

- What are they?
- What is the impact on service creation?

1. SIP semantics that are not visible in PARLAY APIs as per today's specification

- What are they?
- What is the impact on service creation?



The game ...

A multiparty cooperative game

- Group of people trapped in a house with several rooms set to burn/explode in a given time
- Can escape only if password is found
- Letters making the password scattered in selected rooms of the house
- People ending up in the same room can exchange hints about the password via audio and chat
- Game can be assimilated to a conference with as sub-conference people ending up in a same room

Requiring a set of well defined conferencing functionality

- Conferencing
- Sub-conferencing



The game ...





Architecture ...

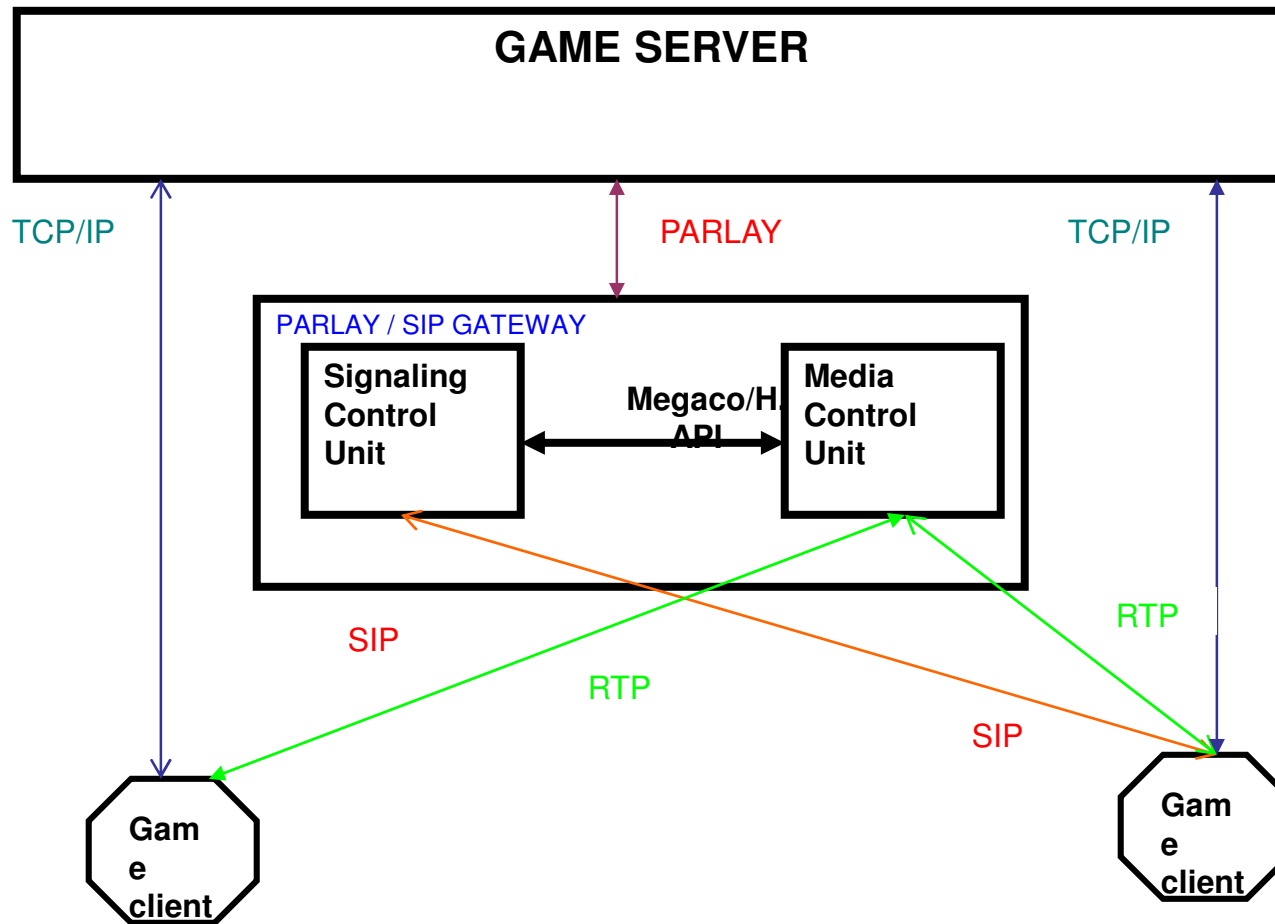



Architecture ...

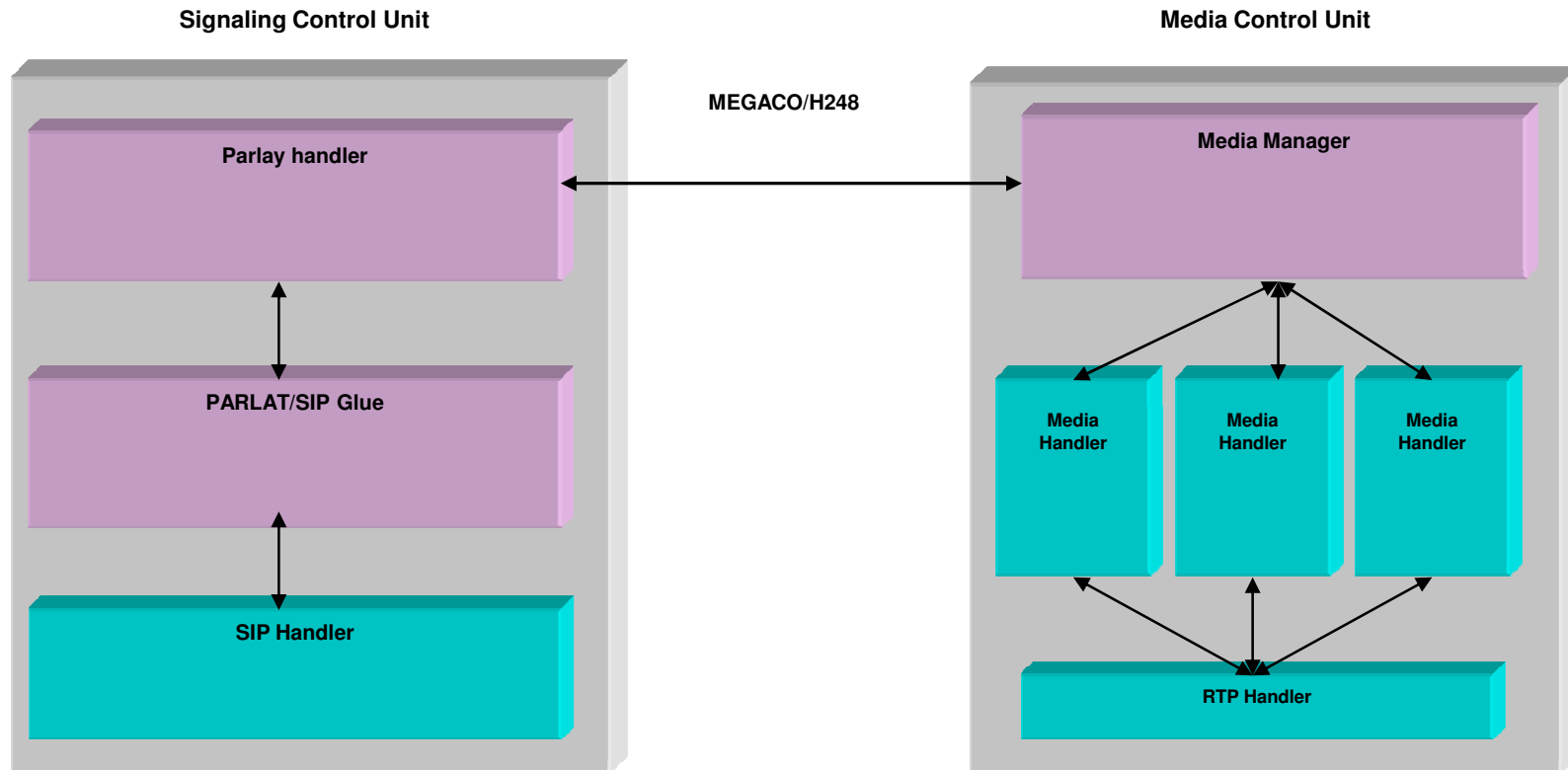



Dial in ..

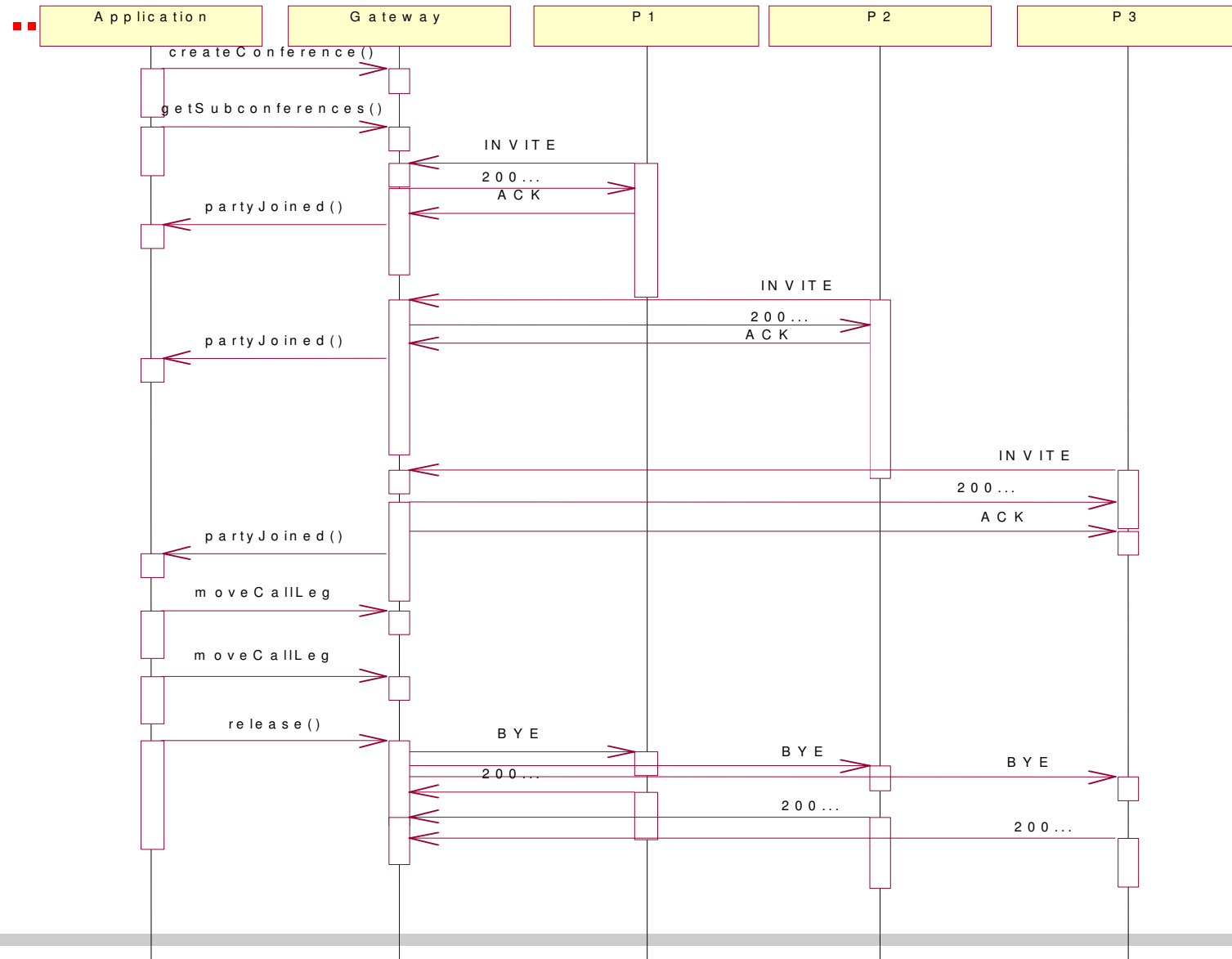
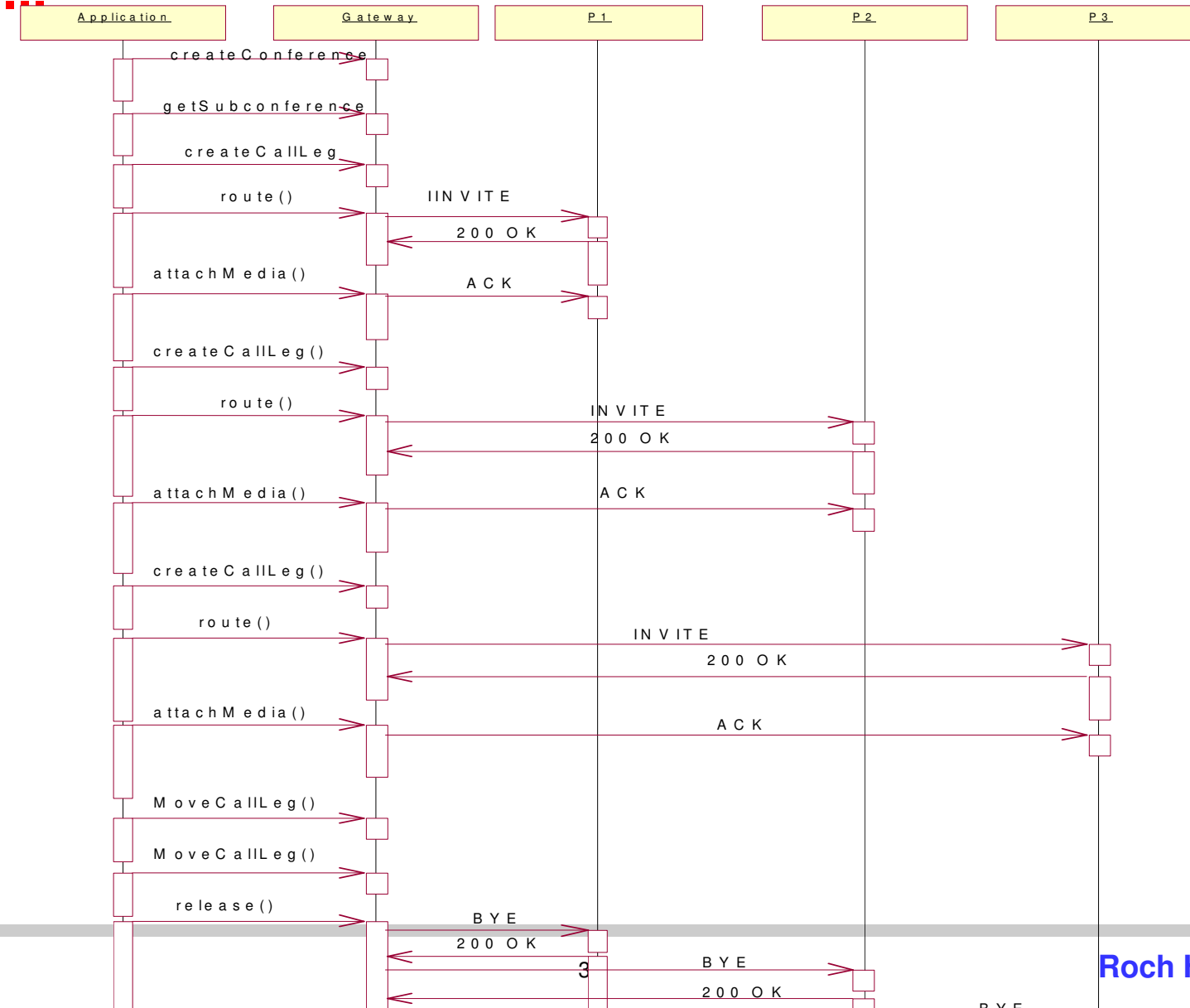

Figure 5 - Mapping for dial-in



Dial out



Roch H. Glitho



The mapping ...

PARLAY Call Control Services that cannot be mapped onto SIP

- There seems to be none
- However the mapping can be done in several ways in some cases

SIP semantics that are not visible in PARLAY APIs as per today's specification

- There exist a few (e.g. Possibility of a caller to state for instance that the call should not be forwarded)
- PARLAY may be extended to cater to these features



Pros and cons ...

Pros

- PARLAY/OSA allows the creation of a wide range of services including services that combine different types of network capabilities (e.g. call control, mobility, presence)
- Parlay allow the creation of services that span several network technologies (e.g. Sip, H.323)

Cons

- The level of abstraction is still low
 - 3N+1 calls were required to create a conference call in older versions of Parlay – The number is now N+1
- Parlay is not easy to grasp by people with no circuit switched telephony/IN background
 - Call leg concept



The Call Processing Language

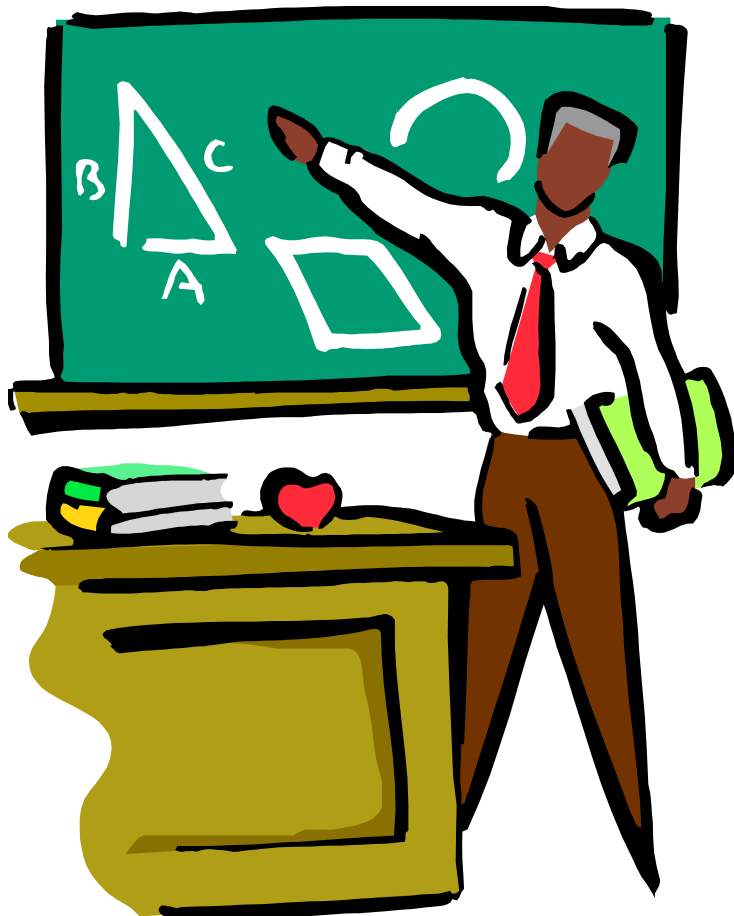

1. Introduction
2. Requirements
3. Constructs
4. Example
5. Pros and cons



Introduction ...

Specificities:

- Only architecture that aims at service creation by end-users

Prime target: Un-trusted parties

- Direct use
- Use via a graphical user interface
 - Higher level of abstraction
 - Mapping done by middle ware

▪



Introduction ...

Targeting end-users has a few consequences:

- Stringent language requirements
- Need to upload scripts to servers
 - REGISTER has been proposed for SIP
 - No mechanism has been proposed for H.323



Requirements on language (From the RFC).

Lightweight, efficient easy to implement

Easily verifiable for correctness

Executable in a safe manner

Easily writeable and parsable

Extensible

Signaling protocol independence



Constructs for an XML Based CPL ...

Switches

- Choices the script can make
 - Address, string, time, priority

Signaling operation

- Cause signalling events in underlying protocol
 - Proxy, redirect, reject

Location modifier

- Add/remove location



Simplified example from the RFC ...

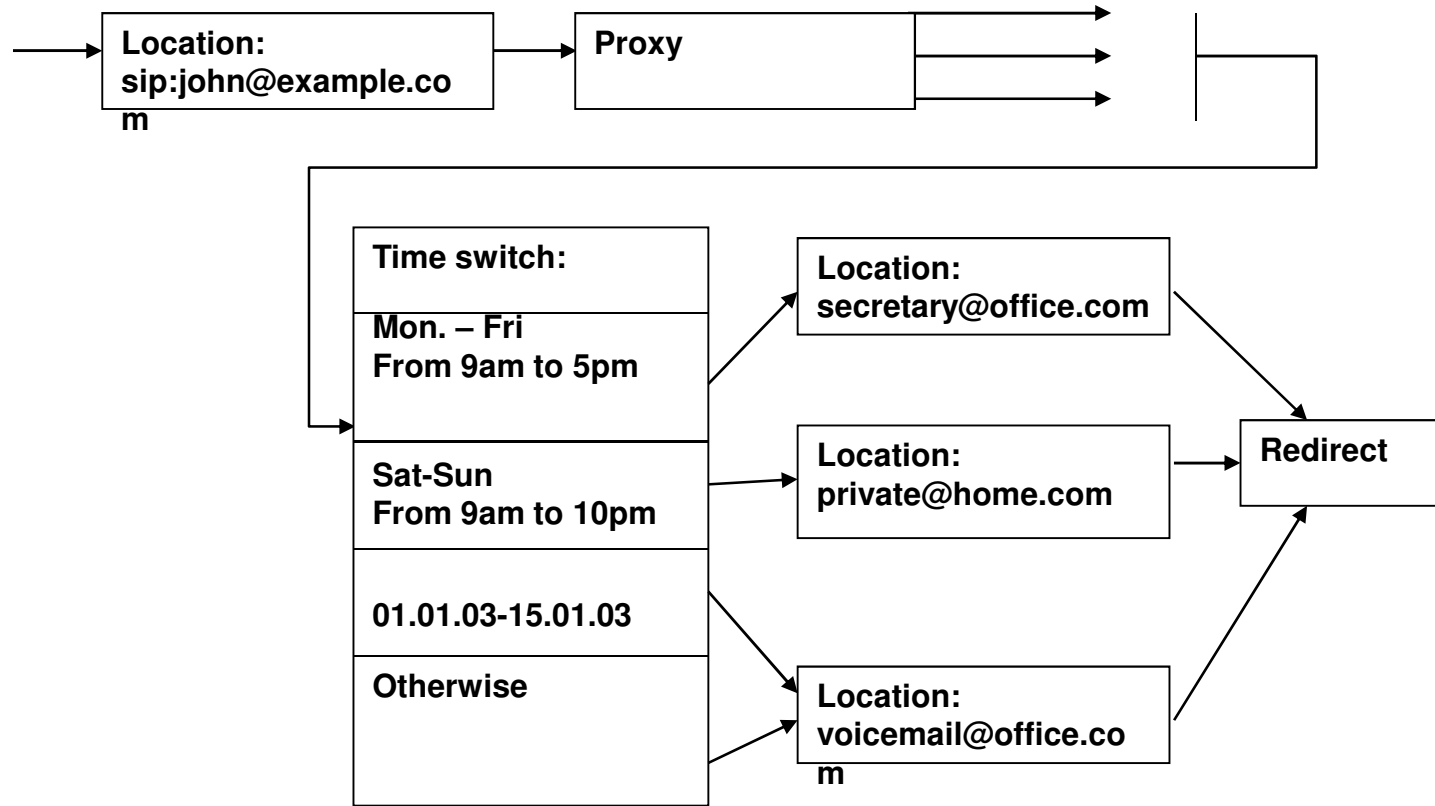



Pros and Cons ...

Highly suitable for service creation by end-users

- End-users familiar with scripts / XML
- End-users unfamiliar with scripts / XML (via GUI)
- Offer required security

However:

- Very few end-users are interested in creating service
- CPL is highly unsuitable for service creation by providers / third parties
 - Range of services that can be created is limited
 - More powerful tools exist
- Service logic and service data need to reside in the same script



To probe further ...

PARLAY:

2. A.J. Moerdijk and L. Klostermanns, Opening the networks with Parlay/OSA: Standards and Aspects behind the APIs, IEEE Network Magazine, May/June 2003
3. R. Glitho and K. Sylla, Developing Applications for Internet Telephony: A case Study on the use of Parlay Call Control APIs in SIP Networks, IEEE Network, May/June 2004, Vol. 18, No. 3, pp. 48 - 55

CPL

RFCs

▪